

Bring
Technology
to Life

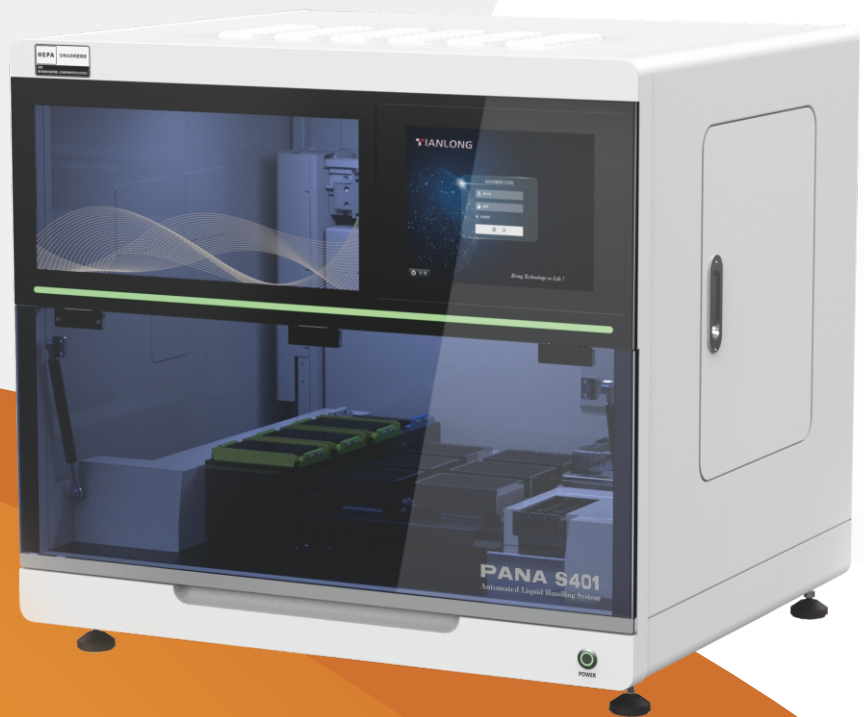

Automated Liquid Handling System

PANA S401



USER MANUAL

Xi'an Tianlong Science and Technology Co., Ltd.

Automated Liquid Handling System

User Manual

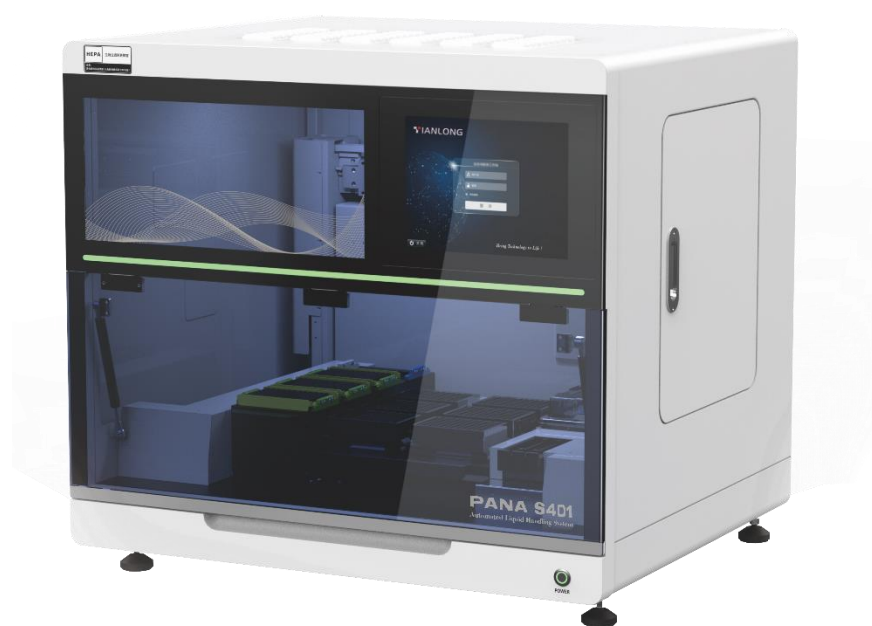

Created by Xi'an Tianlong Science and Technology Co., Ltd.

Disclaimer and Copyright

Copyright© (2021-2024) **Xi'an Tianlong Science and Technology Co., Ltd.** (hereinafter referred to as **XATL Co., Ltd.**). All rights reserved.

All contents of this manual (including but not limited to text, trademark, logo, buttons, icons, graphics, tables, data, etc.) are subject to the copyright and other intellectual property rights of **XATL Co., Ltd.**. These materials shall not be reproduced in any form, neither mechanical nor electronic, nor translated into any other languages without the express written permission of **XATL Co., Ltd.**.

Every effort has been made to ensure that all the information contained in this manual is correct at the time of publishing. However, **XATL Co., Ltd.** reserves the right to make any changes necessary. The contents of this manual are subject to change without prior notice at any time, and the updated revision prevails.

User Manual Document No.: 21EC534201

Version of User Manual: V1.6

User Manual Revision Time: 29-Jan-2024

Applicable Software Version Number of User Manual: V1

Production Date: Refer to the instrument nameplate

Applicable Model of User Manual: PANA S401, PANA S201

Trademark Registration Statement:



is the registered trademark of XI'AN TIANLONG SCIENCE

AND TECHNOLOGY CO., LTD.

Intended Use Statement:

The intended use of Automated Liquid Handling System (hereinafter referred to as **Handling System**) is to complete the liquid handling and processing before the analysis of medical clinical samples, such as nucleic acid pipetting and addition, solution separation and other pre-processing works of nucleic acid detection.

Special Statement:

Before installing and using the Handling System for the first time, please carefully read the instructions in this manual, fully consider the possible range of misoperation or non-recommended function, and pay special attention to the possible consequences.

Contraindications:











Handling System is without contraindications.

User Requirements:





Handling System must be operated by laboratory professionals who have been trained in laboratory technology and have studied this user manual.

Symbols and Markings

A. Labels on Transport Package

Label	Description
	Fragile: The items inside are fragile and please handle with care.
	This Side Up: Indicate the upward side of the transport package.
	Keep Dry: Keep the transport package away from rain or any liquid.
	IVD Instrument: The product belongs to in vitro diagnostic equipment.
	Temperature Limit: Indicate the temperature limits for the storage and transportation of package.
	Humidity Limit: Indicate the humidity limits for the storage and transportation of package.
	Atmospheric Pressure Limit: Indicate the atmospheric pressure limits for the storage and transportation of package.
	No Stack Up: It is prohibited to stack up the instrument package for storage and transportation.
	Recycle: Indicate the packaging materials are recyclable.
	CE Mark: Indicates the instrument is in conformity with In Vitro Diagnostic Medical Devices Regulation (EU) 2017/746.
	Made in China: Indicates that the instrument originated in China.

B. Labels on Handling System

Label	Description
	IVD Instrument: This instrument belongs to In Vitro Diagnostic equipment.
	European Community Representative: Indicate the authorized representative of this instrument in Europe.
	Serial Number: It indicates the serial number of this instrument.
	CE Mark: Indicates the instrument is in conformity with In Vitro Diagnostic Medical Devices Regulation (EU) 2017/746.
	Manufacturer: Indicate the manufacture of this instrument.



Caution: It indicates the “caution” of this instrument.



Manufacture Date: It indicates the manufacture date of this instrument.



Consult Instructions for Use: It indicates the consult instructions for the use of this instrument.



Consult Instructions for Use: It indicates the consult instructions for the use of this instrument.



Biohazard: Indicate that a certain area of the Handling System can be easily contaminated with biological reagents or samples. Reminding user to timely disinfect this area, keep necessary precautions during operation and take corresponding protective measures at the same time.



High Temp.: Indicate that a certain area of the Handling System may produce high temperature. Reminding user to pay attention and be careful for burns.



Warning Danger: Indicate that a certain part of the Handling System may cause personal injury.



Warning Overhead Obstacle: Indicate overhead obstacle of the Handling System may hit head, reminding user to be careful.



Warning Ultraviolet Light: Indicate high-energy ultraviolet lamp of the Handling System, which can cause serious temporary skin irritation, warning user never expose unprotected skin to the area with this mark while the instrument running.



Warning Hands Pinching: Indicate that a certain part of the Handling System may produce extrusion. Remind user never to stretch hands to the area with this mark.

MADE IN CHINA

Made in China: Indicates that the instrument originated in China.

C. Symbols Used in This Manual

Symbol	Description
	Caution: Remind user to pay attention to a certain operation. Operating Handling System in any manner unspecified in this manual may result in instrument damage or abnormal function.
	Reminding: Provide important information regarding to the operation and successful application of Handling System, including the information explained in further detail elsewhere in this manual.
	Prohibit: Prohibit users from a certain dangerous operation. Otherwise, it may result in instrument damage or abnormal function, even constitutes a personal

injury hazard.

D. Conventions Used in This Manual

Convention	Meaning
Ordered List	Operating steps must be performed follow the list order.
Click A	Click A on the touch screen.
<i>Italic + Bold</i>	Indicate the instructions/options of the Handling System software.
< <i>Italic + Bold</i> >	Indicate the keys/icons of the Handling System software.
[]	Indicate the keys on computer keyboard.
<i>Italic + Blue</i>	Indicate the reference chapter or citation.

Safety and Precautions

The operation, maintenance and repair of Handling System shall strictly follow the safety specifications listed in this section and through this manual. The design of Handling System has fully considered its biological contamination protection, electrical safety protection and mechanical motion protection. Non-observance of the instructions or performing any operations not stated herein may affect the safety protection provided, and may also destroy the safety standards of design and manufacture as well as the expected application scope of the Handling System.

XATL Co., Ltd. will not be responsible for any possible consequence caused by either not read or violate the instructions mentioned herein.

 **Caution:** Please carefully read this manual before operating the Handling System. Incorrect understanding or operations may result in instrument damage or inefficiency usage, laboratory damage, even personal injury.



 **Reminding:** Please pay attention to the descriptions with “Caution”, “Reminding”, “Prohibit” symbols, and the safety labels on the instrument and user manual.

I. General Safety and Precautions for Instrument

Handling System follows the demands of IEC61326 and IEC61010.

 **Caution:** No person except the **XATL Co., Ltd** professional engineers are allowed to disassemble, install or transport the instrument, replace the components or debug the

instrument without the authorization of **XATL Co., Ltd.**. If needed, please contact **XATL Co., Ltd.** for professional guidance or professional operation.

-  **Caution:** Please avoid colliding or damaging the instrument and store it carefully.
-  **Caution:** Please carefully examine the instrument and in case of the following situations, please immediately cut off the power supply and contact the supplier or ask the **XATL Co., Ltd.** professional engineer to handle it:

- The instrument suffers from rain or water immersion;
- There is an abnormal sound or odor when the instrument is working;
- The instrument is collided or the shell is damaged;
- There are obvious functional changes of the Handling System.

 **Prohibit:** Never move Handling System while it is running.

 **Caution:** For protection against overheating hazards, the openings on the instrument are designed for ventilation. Please do not block these openings or cover the instrument with dust cover and other materials while it is running.

 **Caution:** If need to install or transport the instrument, please contact **XATL Co., Ltd.** for professionals.





 **Caution:** Please do not open the experiment and waste bin cabin door and, or take out any consumables during the experiment. Otherwise, the bio-safety, electromagnetic radiation and other protective measures set for the instrument may be destroyed, the operation of the instrument may be stopped abnormally and the mechanical arm movement may cause operator injury.

 **Caution:** Please do not forcibly place the consumables (tip, deep well plate, premixing bottle, 96-well plate/8-strip PCR tube, etc.) that do not match this instrument into the experimental operation platform.









 **Caution:** Please do not load any unnecessary items to cabin except the necessary items during experiment, or it may cause abnormal running.

II. Personal Safety and Precautions



 **Caution:** Handling System is heavy, please adopt appropriate tool and method to move or lift it.

-  **Caution:** Handling System is heavy, at least 4 people are required to complete the lifting or moving of the instrument. Please do not move the instrument without the others' cooperation. If lift the instrument with improper methods, it may cause personal injury, pain and instrument damage.
-  **Prohibit:** Please never touch the plug, the power cord or the power switch with wet hands.
-  **Prohibit:** There is a permanent strong magnetic field inside the instrument. Persons with cardiac pacemakers and metal prostheses are not allowed to operate the instrument. The strong magnetic field will affect the function of pacemakers or metal prostheses, and even cause damage.
-  **Prohibit:** There is the moveable component inside the instrument. Please do not stretch any body parts like head and hands into the instrument to keep mechanical injury away.





III. Electrical Safety and Precautions

-  **Prohibit:** The voltage of Handling System can cause harms to human body, please cut off the power supply before opening the instrument shell and it is prohibited to replace any parts of the instrument while it is electrified.
-  **Caution:** Handling System should be properly grounded and any damage of the internal or external grounding path may cause dangerous.
-  **Caution:** In case of electric leakage, Please immediately unplug Handling System and stop using.
-  **Caution:** Please cut off the power before move the instrument.
-  **Reminding:** Please use the instrument attached power cord. If the original power cord is destroyed, please contact **XATL Co., Ltd.** as soon as possible to substitute it with an equal one.
-  **Caution:** This instrument should be properly grounded through grounded wire so as to avoid electric shock. The power cord provided is a standard three-pin plug, please plug it into an appropriate three-wire grounded receptacle (The external grid connected to the receptacle shall be sure to be connected with grounded cord) for operation safety.
-  **Caution:** There must be a grounded cord for the electric grid where the instrument is.
-  **Caution:** Please check whether the power connection is secure carefully. Be sure to hold the plug when plugging and unplugging the power cable and confirm the pins are fully



inserted into the jack. Do not forcibly pull the power cable.

-  **Caution:** Please keep the power cord and plug away from heater or other high temperature objects, do not put anything on the power cord and do not leave the power cable where the people often move around during the instrument operation.
-  **Caution:** The fuse type of Handling System is F10AH250V, located in the fuse tube box at the side instrument. Use improper fuse tube may lead to circuit system damage and cause fire. Please check and confirm the fuse is properly installed before start the instrument.
-  **Caution:** Please check the fuse regularly and if any damage is found, please replace it with the correct type and rated value of fuse specified for this instrument.

IV. Environmental Safety and Precautions

-  **Caution:** Handling System is for indoor use only, the room should be well ventilated and without corrosive gas.
-  **Caution:** Handling System is a 4-point supported instrument, the average load-bearing capacity of the floor where it stands shall be greater than or equal to 0.5 T/m².
-  **Prohibit:** Please never run Handling System in places that have or may have flammable and explosive gas because the electric spark may cause explosion.
-  **Reminding:** The working environment temperature of Handling System should be between 15°C-35°C and the relative humidity should be between 35%-70%.
-  **Reminding:** The working environment atmosphere pressure should be 56.0kPa-106.0kPa (Working altitude of Handling System should be less than or equal to 4 km).

V. Biological Safety and Precautions

-  **Biohazard:** The processing object of Handling System is biological samples which are featured with the potential risk of spreading infectious disease. Please consider them all as the samples with potential biohazard. Please take applicable safety protection measures like wearing appropriate protective goggles, clothing and gloves while processing the samples.
-  **Biohazard:** Please comply with the local or national applicable regulations to complete the disposal of waste and contaminated materials.
-  **Biohazard:** The user should consider the abandoned Handling System as biological

contaminated material and comply with the local or national applicable regulations to complete the instrument disposal. Before disposal or recycle the instrument, please completely clean and disinfect the instrument.



Biohazard: If there is some liquid sample flowing out during any instrument operating, please immediately take the proper disinfectant to disinfect the instrument according to *“6.14 Powerful Cleaning”* to avoid the contamination spreading to the testers or contaminating the instrument

CONTENT

1. Overview.....	1
1.1 INTENDED APPLICATION.....	2
1.2 PRODUCT CHARACTERISTICS INTRODUCTION.....	2
1.2.1 <i>Function Characteristics</i>	2
1.2.2 <i>Instrument Hardware Characteristics</i>	3
1.2.3 <i>Software System Characteristics</i>	3
1.2.4 <i>Consumable Compatibility</i>	3
1.3 PRODUCT PARAMETERS INTRODUCTION.....	4
1.3.1 <i>General Parameter of Instrument</i>	4
1.3.2 <i>Performance Parameter of Instrument</i>	5
2. Unpacking and Installation	6
2.1 UNPACKING INSTRUCTIONS.....	6
2.2 WORKING ENVIRONMENTAL REQUIREMENTS.....	9
2.2.1 <i>Space Requirements</i>	10
2.2.2 <i>Power Requirements</i>	10
2.3 REMOVE TRANSPORT LOCK.....	11
3. Product Composition and Structure	12
3.1 INSTRUMENT STRUCTURE AND COMPOSITION.....	12
3.2 OPERATION PLATFORM.....	16
4. Preparation before Experiment.....	18
4.1 START HANDLING SYSTEM.....	18
4.2 SYSTEM LOGIN AND SELF-INSPECTION.....	18
4.3 MATERIAL LOADING.....	20
4.3.1 <i>Load Consumables in Tip Area</i>	21
4.3.2 <i>Load Consumables in PCR Setup and Reservation Area</i>	21
4.3.3 <i>Load Consumables in Reagent and Premix Area</i>	22

4.3.4 Load consumables in Eluent Area	24
5. Handling System Software Operation.....	26
5.1 MAIN INTERFACE.....	26
5.2 EXPERIMENT PREPARATION.....	28
5.2.1 Experiment Item	28
5.2.2 Sample Settings.....	29
5.2.3 Reagents/Consumables Settings.....	34
5.3 START THE EXPERIMENT.....	39
5.4 EXPERIMENT MONITORING.....	39
5.5 SYSTEM SETTINGS	42
5.5.1 Maintenance.....	42
5.5.2 Settings.....	47
6. Instrument Maintenance and Cleaning.....	54
6.1 INSTRUMENT CLEANING OPERATION INSTRUCTIONS.....	54
6.1.1 Clean Instrument Shell.....	54
6.1.2 Clean Touch Screen	55
6.1.3 Clean Experiment Cabin.....	55
6.1.4 Powerful Cleaning.....	56
6.2 INSTRUMENT MAINTENANCE INSTRUCTIONS	56
6.2.1 Maintain Adequate Ventilation	56
6.2.2 Maintain Stable Power Supply.....	57
6.2.3 Maintain Instrument Clean	57
6.2.4 Replace Waste Bin	57
6.2.5 Replace Fuse	58
6.2.6 Replace UV Lamp	58
6.2.7 Replace Filter	58
6.2.8 Other Maintenance and Calibration.....	59
6.3 PACKING, TRANSPORT AND RETURNING TO FACTORY SERVICE.....	60
6.3.1 Instrument Cleaning and Disinfection.....	60
6.3.2 Transport Lock Installation	61
6.3.3 Product Package.....	61
6.4 TROUBLESHOOTING.....	62
6.5 DATA MAINTENANCE.....	64
6.5.1 Log.....	64
6.5.2 Data Backup	64

6.5.3 Data Recovery	64
7. Contact Information	65
Annex I. Quick Guide of Experiment Operation	66
Annex II. Accessories List and Usage	68
Annex III. Wooden Case Unpacking Instructions	69
Annex IV. Carton Box Unpacking Instructions	74

User Manual Modification Points between Versions				
SN	Modification Point	Current Version	Page	Date
1	Manual version; Modification time	V1.6	II	29.01.2024
2	“Made in China” label description		IV;V	
3	Accident report reminding		63	
4	Contact information		65	
5	Accessories List		68	
<p>Note: This modification points are only for client reference. If you need modification details, please contact XATL Co., Ltd. after-sale service referring to “7. Contact Information”.</p>				

1. Overview

1.1 Intended Application

The intended use of Handling System is to complete the liquid handling and processing before the analysis of medical clinical samples, such as nucleic acid pipetting and addition, solution separation and other pre-processing works of nucleic acid detection.

1.2 Product Characteristics Introduction

1.2.1 Function Characteristics

- ▶ **Running Duration:**
Complete 96 throughputs processing within 10 minutes.
- ▶ **Pipetting Range:**
5 μ L~1000 μ L (Single aspiration and dispense), automatically turn to the multi-operation mode if the volume is over 1000 μ L.
- ▶ **Liquid Level Detection:**
Liquid level detection of capacitance & pressure sensing ensures the highly accurate pipetting.
- ▶ **Reagent Refrigeration:**
The refrigeration cabin adopts light proof design, which can automatically refrigerate reagent at low temperature (4 $^{\circ}$ C~8 $^{\circ}$ C) after startup.
- ▶ **Consumable Identification:**
Automatically identify all consumables, timely monitor the consumable loading and consuming status, providing operator with necessary prompts.
- ▶ **Silent Running:**
Double mute design of mechanical operation control and sound insulation cabin door ensure the running noise of instrument is less than or equal to 70 db.
- ▶ **Contamination-proof:**
 - **Anti-drip:** The pipetting device has excellent air tightness anti-drip performance, and is equipped with an external droplet capture;
 - **Negative Pressure System:** The airflow control device has excellent air-exhaust performance to realize negative pressure monitoring in cabin.
 - **HEPA Filtration:** The detachable HEPA filter is installed over ventilation opening. The system will remind user to replace the HEPA filter when it exceeds the rated service time.
 - **UV Disinfection:** The UV disinfection devices are equipped in multiple areas, that can be manual or automatic activated.

- **Reagent Aliquot:** Handling System is able to aliquot 8 pieces of PCR Plates equaling to 768 tests' reagents within 10 minutes.

1.2.2 Instrument Hardware Characteristics

▶ **Pipetting Device:**

Handling System is equipped with 2 (S201) and 4 (S401) independent air displacement pipettors (ADPs) respectively. The pipetting range is 5 μ L ~1000 μ L.

▶ **Visual Device:**

A set of dedicated high-definition camera is for identifying the consumable.

▶ **Master Computer:**

A master computer is equipped inside Handling System that is with a 12.1-inch touch screen.

▶ **Motion Device:**

The high-precision controlled motors move on mechanical arms along X, Y, Z three directions to ensure accurate movement of the pipetting device.

▶ **UV lamp:**

Handling System is equipped with 2 same models UV disinfection lamps on the top of the cabin.

1.2.3 Software System Characteristics

▶ **Software Interface:**

Wizard interface, intuitive sample layout and experiment setting, easy to operate.

▶ **Software Function:**

- Support to set up different programs according to different experimental requirements.
- Support instrument reset, self-inspection, module maintenance, UV disinfection and other functions.
- Support real-time monitoring of experiment and operation progress during the whole process of experiment.
- Support automatic reservation function of extraction products for result track and recheck.

▶ **Language:**

Chinese and English.

1.2.4 Consumable Compatibility

▶ **General Consumables:**

- **PCR Tube:** 0.1mL & 0.2mL 8-strip PCR tube or 96-well PCR plate, please select the PCR

tube according to the PCR instruments.

- **Reserve Tube:** 0.1mL & 0.2mL PCR tube/96-well plate.

▶ **Dedicated Consumables:**

- **Pipetting Tip:** 2 dedicated types of filter tips (5 μ L-50 μ L; 50 μ L-1000 μ L).
- **Premixing Bottle:** Dedicated premixing bottle for PCR setup.

❗ **Reminding:** The dedicated consumables provided by **XATL Co., Ltd.** can not be substituted with other ones. Otherwise, the instrument parameters errors may occur due to the consumable differences, which may lead to experiment failure.

1.3 Product Parameters Introduction

1.3.1 General Parameter of Instrument

▶ **Instrument Specification:**

Dimension: 860mm(L) × 735mm (W) × 800mm (H);

Weight: 103kg

▶ **Package Specification:**

Wooden Case Dimension: 1020mm(L) × 880mm (W) × 1010mm (H); Weight: 165kg;

Aviation Case Dimension: 975mm(L) × 815mm (W) × 1165mm (H); Weight: 187kg;

Carton Box Dimension: 1020mm(L) × 891mm (W) × 1050mm (H); Weight: 136kg;

▶ **Power Specification:**

Voltage: AC 100-240V;

Frequency: 50/60Hz;

Rated Power: 600VA;

► **Communication Specification:**

 USB 2.0 interface

- ❗ **Reminding:** The USB interface of Handling System is only to connect USB disk, mouse and keyboard.
- ❌ **Prohibit:** The USB interface of Handling System is prohibited to charge for the external devices.
- ❗ **Reminding:** The device connected to Handling System via USB interface needs to pass the safety certification to ensure that Handling System will not be damaged.
- ❌ **Prohibit:** Please do not connect any devices via USB interface while Handling System is running.
- ❗ **Reminding:** The rated voltage of the device that connects to Handling System by USB interface is $5V \pm 5\%$ and the rated current is 500mA.
- ❗ **Reminding:** Please format the USB disk as FAT32 before connect it to Handling System and ensure there leaves enough GB in USB flash drive, 1 GB is recommended.

► **Application Environment:**

Temperature: 15°C -35°C

Relative Humidity: 35%-70%RH, non-condensing;

Atmospheric Pressure: 56.0kPa-106.0kPa (Altitude: $\leq 4000\text{m}$)

► **Storage and Transportation Environment:**

Temperature: -40°C-55°C. The instrument package is within transport package.

Relative Humidity: 0-93% RH

Atmosphere Pressure: 26.4-106.0kPa

1.3.2 Performance Parameter of Instrument

► **Pipetting Accuracy:**

Below 15 μL : The relative deviation is less than or equal to 2.0%;

15 μL -50 μL : The relative deviation is less than or equal to 1.5%;

Above 50 μL : The relative deviation is less than or equal to 1.0%;

► **Pipetting Repeatability:**

Below 15 μL : $CV \leq 3.0\%$;

15 μL -50 μL : $CV \leq 1.5\%$;

Above 50 μL : $CV \leq 1.2\%$;

2. Unpacking and Installation

2.1 Unpacking Instructions

Handling System is transported via aviation case which is made up of roof plate and bottom support plate that are connected with buckles, as shown in figure 2-1. It is tightly and evenly wrapped with PE stretch film and fixed inside the aviation case to prevent the collisions and shocks during transport.

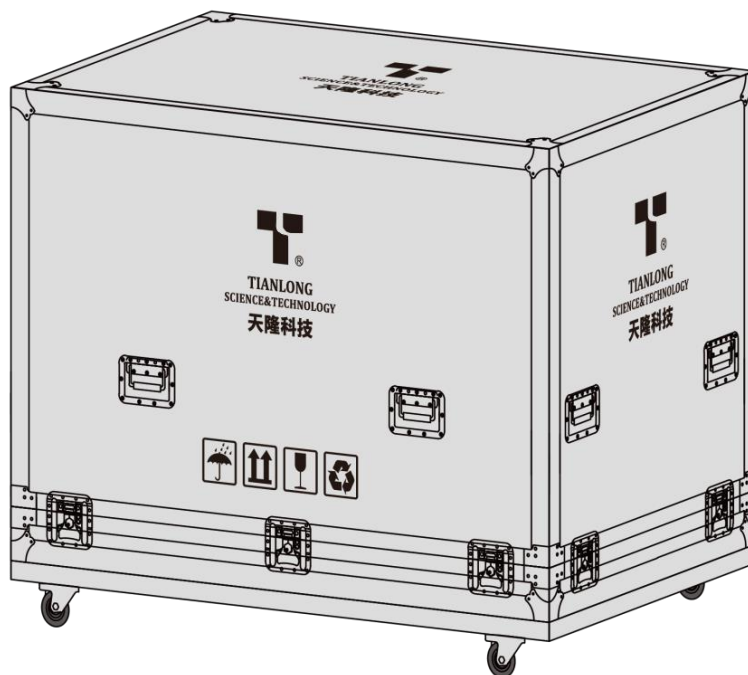

Figure 2-1. Aviation Case External View

The unpacking of aviation case mainly includes 4 steps. The specific operations are as followings.

- 1st Step:** Please release the bottom circle buckles of the aviation case and then remove roof plate with hands holding the handles, as shown in figure 2-2a.

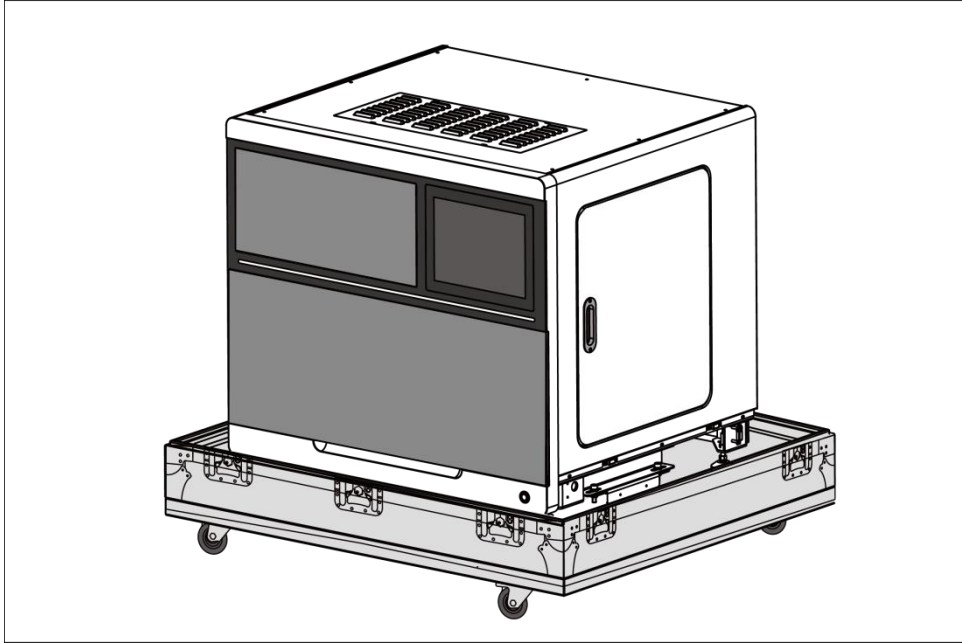

Figure 2-2a. Remove Aviation Case Roof Plate

2nd Step: Please unscrew the 4 screws fixed in two sides of the instrument by monkey wrench, as shown in figure2-2b.

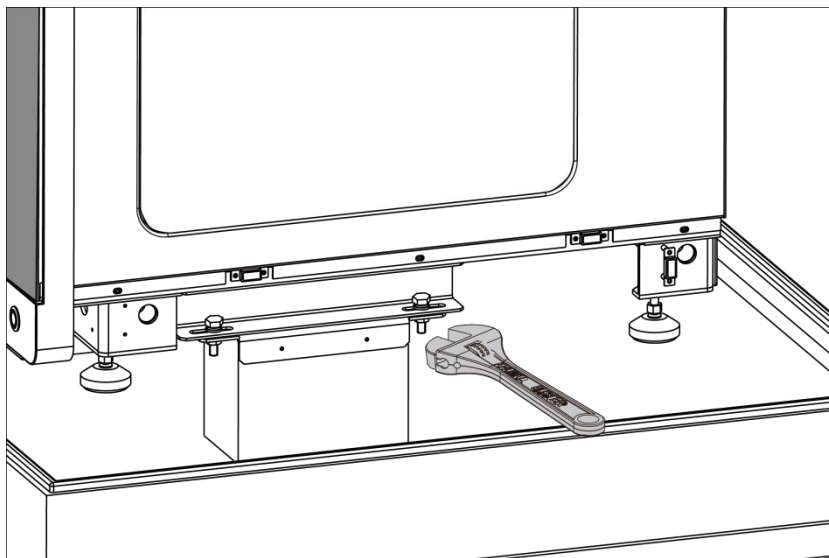

Figure 2-2b. Unscrew

3rd Step: Install four transport handles in each slot beside every supporting foot, as shown in figure 2-2c. With persons' cooperation, please together lift the instrument out of the package with hands holding the handles and instrument body and transport to the predetermined location for installation.

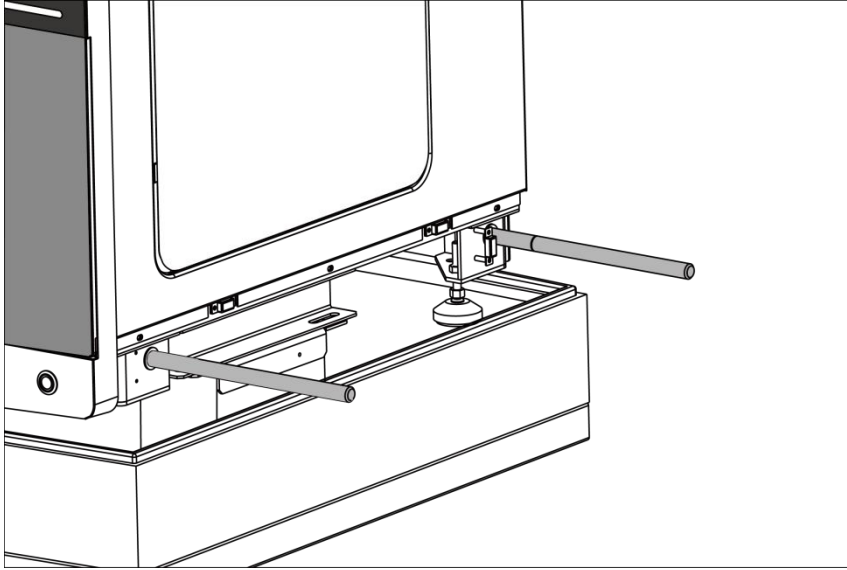

Figure 2-2c. Transport Handles Application

4th Step: Please place Handling System on a steady platform, rotate down the supporting feet to land. Adjust supporting feet to the same level to ensure Handling System stands steadily before installing the magnetic plate on instrument's two sides, as shown in figure 2-2d.

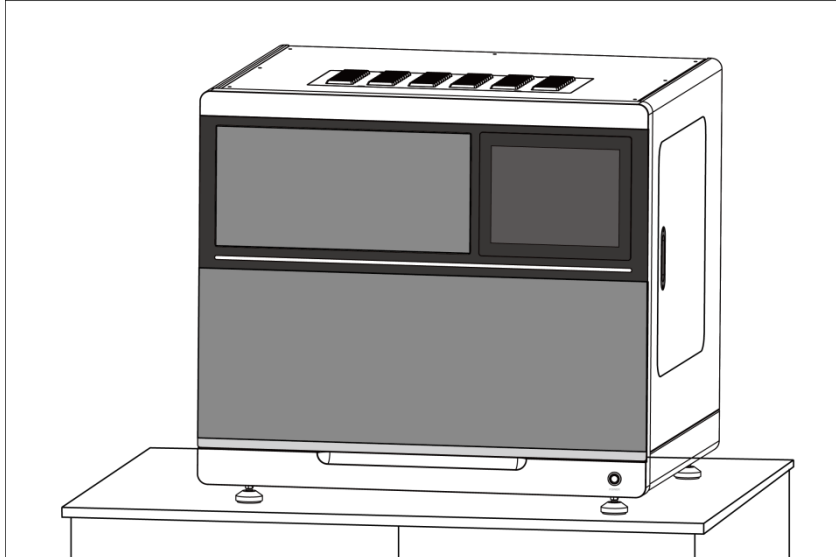

Figure 2-2d. Adjust Supporting Feet Height and Install Magnetic Plate

⚠ Reminding: In order to prevent the formation of condensation water, please do not open the package until it reaches room temperature.

- ❗ **Reminding:** Please carefully check the package integrity and the anti-collapse card outside the package before open it. If you are confronted with these following situations, please do not unbox and contact the transport department or **XATL Co., Ltd.** to solve the problems.
 - The anti-collapse card shows the case was ever collapsed during transportation;
 - The case material is abnormal or has been opened;
 - There is collision trace on the case or the damage and deformation occur;
 - The water stain or waterlogging lies on case.
- ❗ **Reminding:** The attached files are all placed in the case while the instrument accessories are transported independently. Please refer to the packing list for details. Please check and receive the product and accessories according to the packing list after unboxes. If something is missed, please contact **XATL Co., Ltd.** or the agency to supplement immediately.
- ❗ **Reminding:** Please fill in the relevant content on installation information feedback table after product acceptance and send it back to **XATL Co., Ltd.** for filing and warranty.
- ❗ **Reminding:** If there's no special situation, the product should be unboxed and installed by the professionals.
- ⚠ **Caution:** The transport package of Handling System is designed to reduce the instrument damage and ensure its safety. Adopt other packaging materials will break the warranty and **XATL Co., Ltd.** will not be responsible for damages as consequences of improper packaging that incurred during the transportation. Please also keep the instrument related documents provided by **XATL Co., Ltd.** for future use too.
- ❗ **Reminding:** If the user receives the instrument packed with wooden case, please see [Annex III. Wooden Case Unpacking Instructions](#) for details, while if it is carton box, please see [Annex IX. Carton Box Unpacking Instructions](#) for details.

2.2 Working Environmental Requirements

Handling System is only placed and used indoors and there are requirements on the indoor power, ventilation, etc.

2.2.1 Space Requirements

- 1) Handling System should be used in the room with low humidity and appropriate temperature. The room should be well ventilated with clean and dry air and without corrosive gas, explosive gas, dust and ash.
- 2) Please keep Handling System away from heat sources (directly sunshine, heater, stoves) and water sources (such as water pool, water tube etc.).
- 3) The working environment of Handling System should be without electromagnetic interference, vibration and high frequency wave electrical equipment.
- 4) Handling System should stand on a steady and firm working bench and the average load-bearing capacity of the working bench shall be greater than or equal to 0.5T/m².
- 5) Please leave sufficient space around the instrument (at least leave 20cm at left, 70cm at right sides, 15cm at backside and 100cm in front of the instrument).
- 6) For protection against overheating hazards, the openings on Handling System are designed for ventilation. Please do not block or cover these ventilation openings while it is running.
- 7) Please do not place Handling System close to the wall or pile up other goods at the rear of the instrument, this may affect heat dissipation.
- 8) Please place the instrument where is easy to plug and unplug and do not place it where is hard to unplug.

2.2.2 Power Requirements

- 1) The power grid environment of Handling System should possess ground wire and the instrument should be properly grounded.
- 2) The power specifications of Handling System are listed in ***“1.3 Product Parameters Introduction – 1.3.1 General Parameters of Instrument”***, use improper power may damage the circuit system and cause fire, it is recommended to use UPS power supply.

 **Reminding:** Before connecting the AC power supply, please ensure the consistent of the Handling System required voltage and the power supply voltage (allowable deviation $\pm 10\%$). And make sure that the rated load of receptacle is no less than the requirement of the instrument.

 **Reminding:** If the power supply system of Handling System working environment is unstable like higher or lower, it is required to equip with over 600VA AC regulated power supply and please do not connect other electrical equipment at the same power circuit.

 **Caution:** Generally, please use the power cord attached with the instrument.

- ⚠ Caution:** Please check the power cord periodically. If it is found to be damaged, please contact **XATL Co., Ltd.** to substitute with an equal one.
- ⚠ Caution:** Please do not put anything on the power cord and keep it away from places where people move around. Please do not put the power port in an area where is difficult to operate. The user should plug and unplug the power with hands holding the plug and do not forcibly pull the power cable.
- ⊘ Prohibit:** Spraying liquid on electrical parts may cause a short circuit and result in fire, do not use sprays in vicinity of the instrument.

2.3 Remove Transport Lock

After unpacking, please do not directly power on Handling System. Please remove the transport lock and then run the instrument.

Six transport locks are located in Handling System, 2 for X-axis, 2 for Y-axis, 1 for Z-axis inside ADP protection cover and 1 for longitudinal drawer, as shown in figure 2-3. It is not requested for the order of unlocking 6 transport locks while the user should start the instrument after ensuring to unlock all the transport locks.

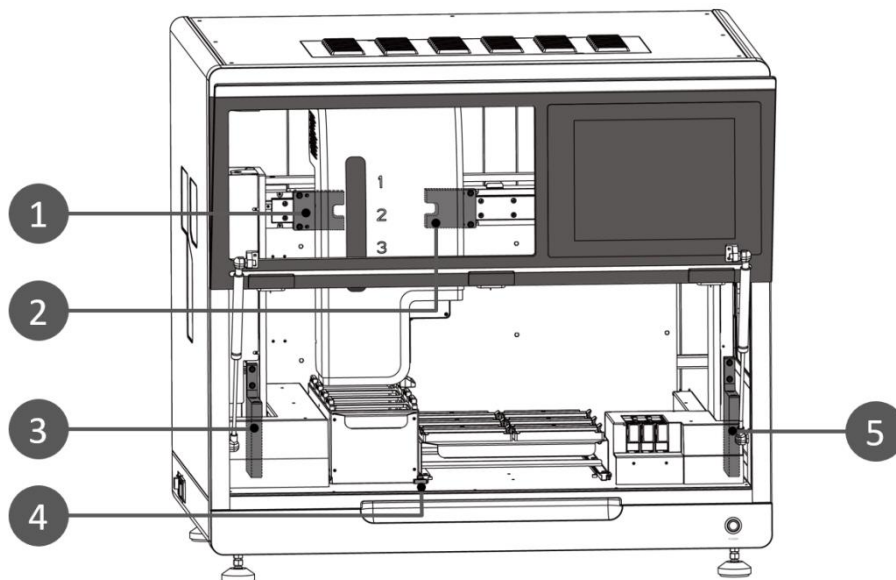

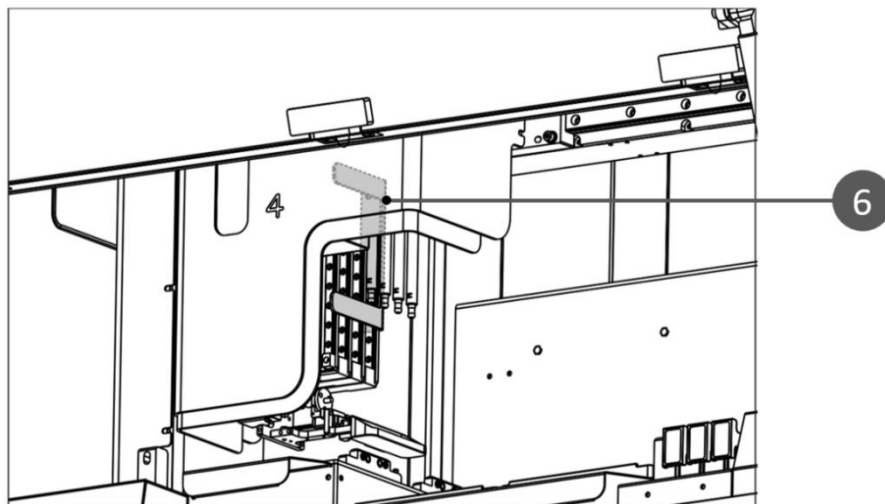

Figure 2-3. Transport Lock Location

1&2. Transport lock in X-axis

3&5. Transport lock in X-axis

4. Transport lock for longitudinal drawer

6. Transport lock in Z-axis

- ⚠ Caution:** Under normal circumstances, the transport lock of Handling System must be unpacked or installed by professional engineer from **XATL Co., Ltd.**
- ⚠ Caution:** Please do not remove any screws or other parts unless it is specifically mentioned in this manual. This kind of behavior violates the warranty and may cause the instrument out of alignment.

3. Product Composition and Structure

3.1 Instrument Structure and Composition

The intended use of Handling System is to complete nucleic acid detection pre-processing works, such as reagent and nucleic acid pipetting, separation, adding, etc.

Handling System is composed of two main modules (pipetting module and refrigeration module) and the other necessary functional modules (experiment operating platform, shell, power supply, HCl, etc.), Please refer to figure 3-1 for instrument structure.

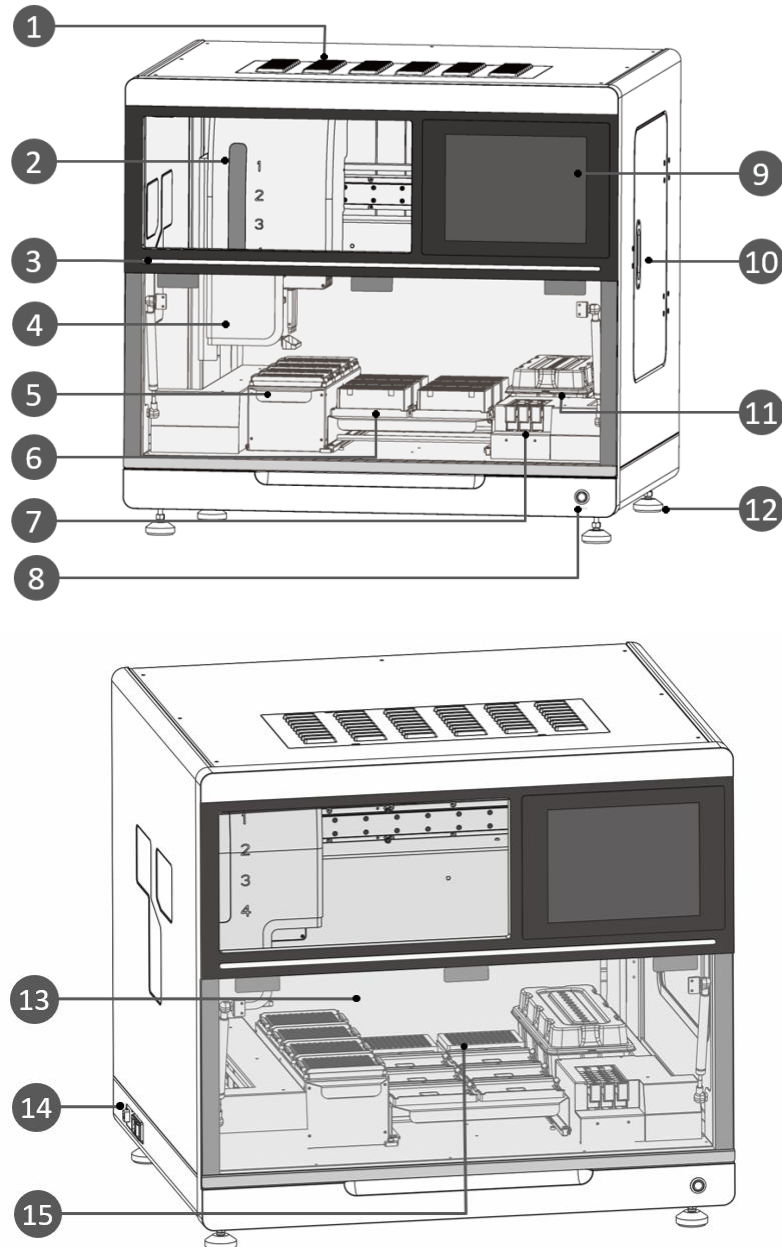

Figure 3-1. Instrument Structure

1. HEPA Filter:

It is intended for filtering the harmful particles or gas like aerosol to prevent contamination.

2. ADP Indicator Light:

There are four indicator lights ① ② ③ ④ which respectively indicates the status of four pipetting devices.

⚠ **Reminding:** The ③ ④ indicator lights of PANA S201 Handling System are always off.

3. Status Indicator Lights:

The light indicates Handling System current status by displaying the different colors.

- **Blue Light Flickering:** Indicates Handling System is on;
- **Green Light On:** Indicates Handling System is normal;
- **Yellow Light Flickering:** Indicates there is a warning;
- **Yellow Light On:** Indicates there is a fault.

4. Pipetting Module:

The pipetting module contains a camera, 2 or 4 independent ADPs and an ADP protection cover. The pipetting module could move on the mechanical arms along X and Y direction for liquid transferring and consumable information identification.

- **Pipetting Device:** Handling System is equipped with 2 (S201) and 4 (S401) independent air displacement pipettors (ADPs) respectively.
- **Camera:** The high-definition camera can move along with the pipetting device and identify consumable information;
- **ADP Protection Cover:** The shell of pipetting device which is equipped with ADP indicator lights.

5. Tip Area:

The tip area could load 4 tip holders (from inside to outside, the tip holders are numbered as No. 1, No. 2, No. 3 and No. 4), the different color of tip holder represents the different tip specification.

50 μ L tips are loaded in the No. 1, No. 2 and No. 3 green tip holder.

1000 μ L tips are loaded in the No. 4 yellow tip holder.

6. Eluent Area:

The eluent area could load six deep well plates (DWP). The DWP should be properly loaded into each loading site with its triangle notch located in bottom-left corner.

7. Reagent and Premixing Area:

This area is located within refrigeration cabin, which is designed for loading reagent component and premixing bottle and can be automatically refrigerated at low temperature (4 $^{\circ}$ C~8 $^{\circ}$ C) after startup.

8. Instrument Switch:

The instrument switch is a quick power switch on the instrument. To press it down means the instrument is on and pressing it again means off.

9. Touch Screen:

The touch screen is a HCI interface that used for Handling System.

10. Right Cabin Door:

If necessary, the user could open the right cabin door to replace waste box or undertake other maintenance.

11. Waste Cabin:

This area could load one single-use waste bin where the waste tip is unloaded by ADP and drops through inlet.

12. Supporting Foot:

Handling System is supported by four supporting feet.

13. Experiment Cabin Door:

The cabin door keeps the experiment cabin an independent space and the user could upturn the door to open the cabin.

14. Power and Network Interface:

The power and network Interface of Handling System is as shown in figure 3-2, which is located on the side wall of the Handling System.

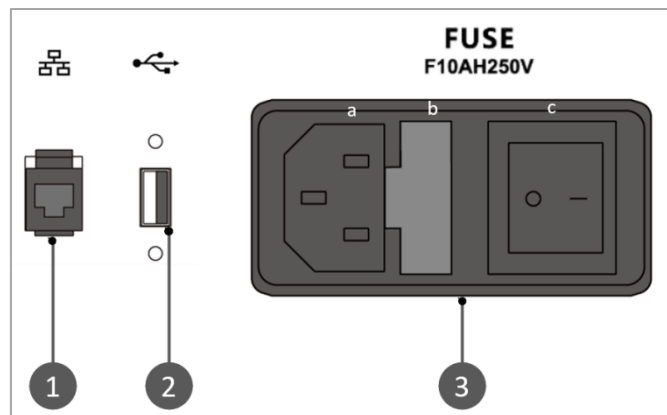

Figure 3-2. Power and Network Port

① **Network Port:** The ethernet port for switch connection.

② **USB Interface:** The USB interface is only for connecting USB flash drive, mouse and keyboard.

③ **Three-in-one Receptacle:** a. power inlet; b. fuse tube cabin; c. power switch.

⊘ **Prohibit:** The USB interface cannot be used for charging.

- ❗ **Reminding:** Please format the USB disk to FAT32 before connect it to the instrument and ensure there is enough GB for U disk, 1 GB is recommended.

15. PCR Setup and Reservation Area:

This area is equipped with 2 movable PCR loading plates whose bottom is fixed via magnetic supporting holder.

3.2 Operation Platform

Please upturn the cabin door and the whole operation platform is in front of the user, as shown in figure 3-3.

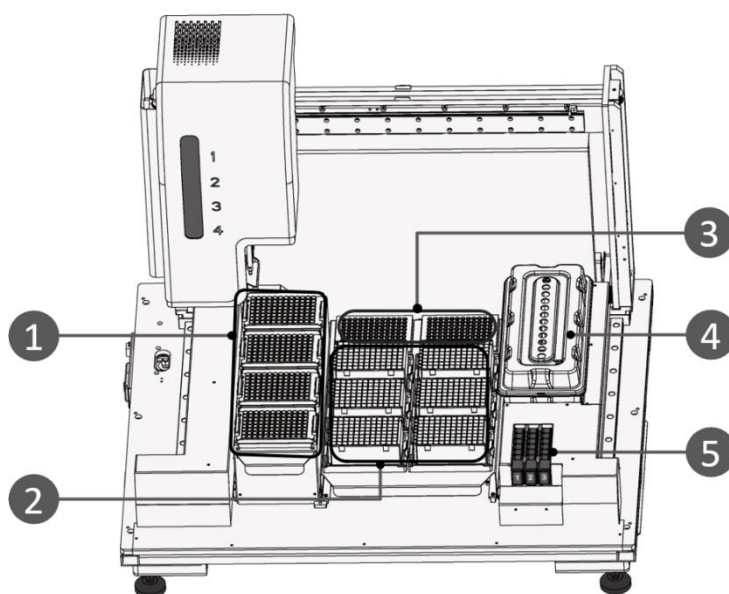

Figure 3-3. Operation Platform

1. Tip Area:

The tip area could load 4 tip holders, including three 50 μ L tip holders and one 1000 μ L tip holder.

2. Eluent Area:

The eluent area is designed as a longitudinal drawer which can be pushed and pulled for the user conveniently loading eluent and where can be loaded 6 DWPs (1mL or 3mL) with eluent loaded or 6 PCR plates. Please see details in [“4.3.4 Load Consumables in Eluent Area”](#).

3. Setup/Reservation Area:

Two moveable PCR loading plates can be magnetically mounted in this area, which could hold 24 8-strip tubes or 2 96-well PCR plates.

4. Waste Cabin:

This area could load one single-use waste bin where the waste tip is unloaded by ADP and drops through inlet.

5. Reagent and Premixing Area:

This area is located within refrigeration cabin, which is composed of three reagent/premix bottle holders, each of which can hold six reagent/premix bottles. Holder 1# and 2# is for placing reagent bottles. Holder 3# could hold six premixing bottles which are intended for premixing the mutual-independent 6-group of reagent components. Meanwhile, a reagent trough is equipped for the user aliquoting reagent.

4. Preparation before Experiment

4.1 Start Handling System

1st Step: Please turn on the power switch on the side wall of the Handling System.

2nd Step: Then turn on the instrument switch on the instrument panel.

⚠ Caution: Before power on the Handling System, please ensure the transport lock of the Handling System has removed. And the power supply is properly connected.

4.2 System Login and Self-inspection

1st Step: After starting Handling System, user can double click  on instrument screen to start the application software and Handling System will automatically undertake self-inspection and initialization, as shown in figure 4-1.

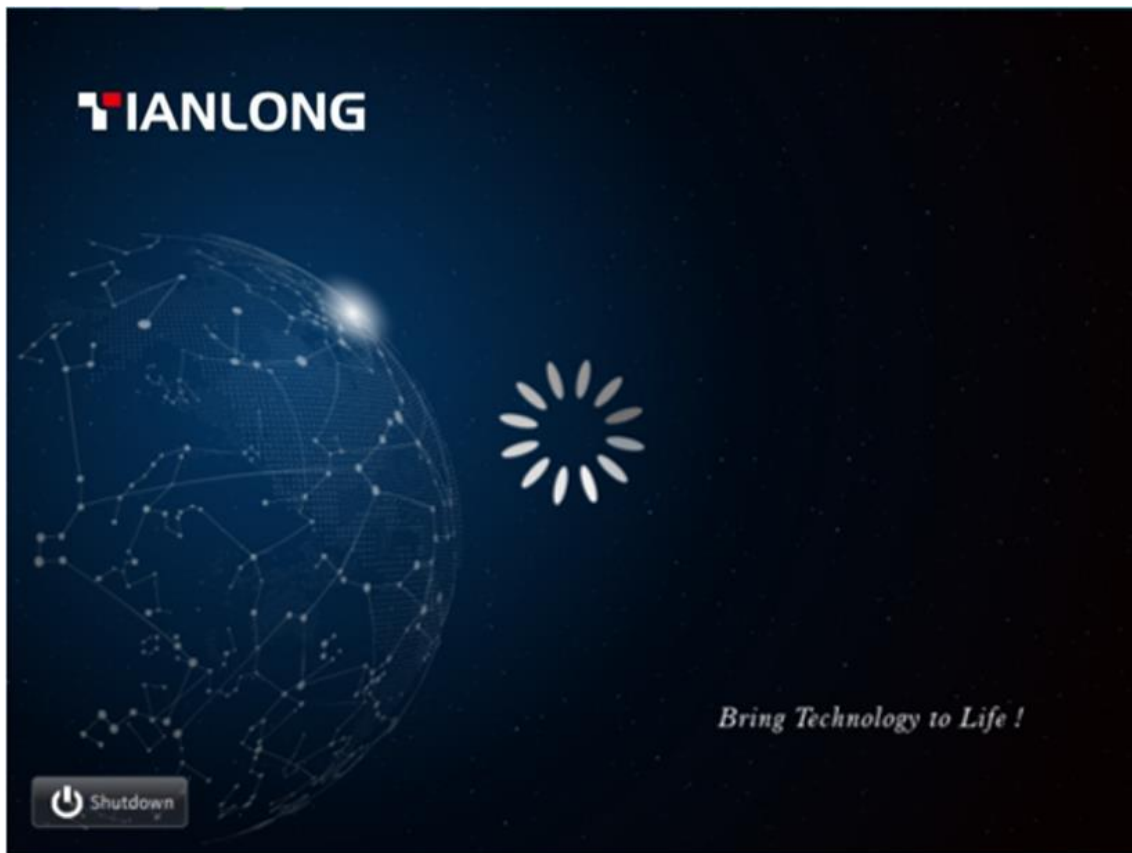

Figure 4-1. Self-inspection Interface

⚠ Caution: If Handling System fails to pass the self-inspection, please restart the instrument, in case Handling System still fails to pass the self-inspection, please contact the distributor or **XATL Co., Ltd.**, do not slap or shake the instrument.

2nd Step: After the system self inspection, the master touch screen displays the login interface, as shown in figure 4-2.

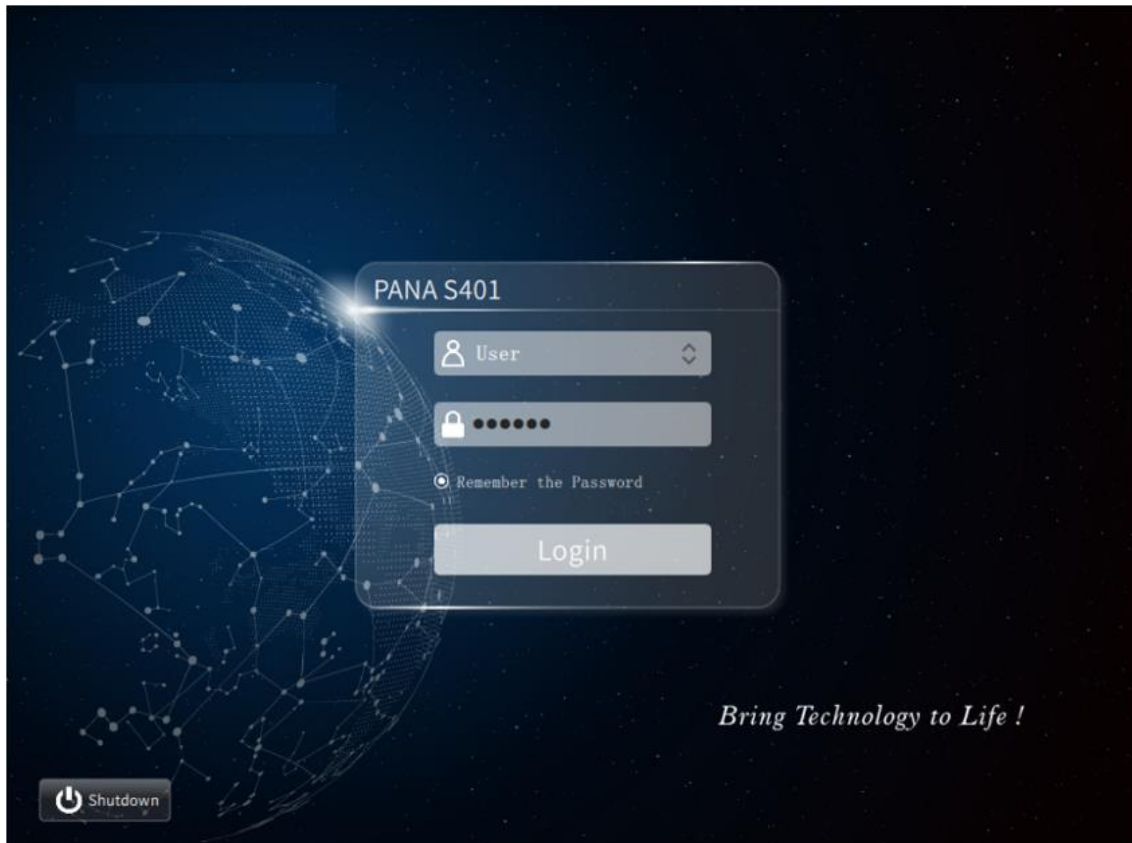



Figure 4-2. Login Interface

User can select a user account after the  icon, enter the login password after the  icon and click < **Login** > to login the system software as the current account.

- ⚠ Reminding:** **XATL Co., Ltd.** professional engineer will use the **Admin** account to login Handling System software for the first time and add new user account after login.
- ⚠ Reminding:** User can change the password after login, please remember the password, otherwise you will not be able to login the system software without the permission of the **Admin** account.

3rd Step: After logs in Handling System, the touch screen of the master computer displays the main interface, as shown in figure 4-3. The user could set the sample and experiment here, please see details in **“5- System Software Operation”**.



Figure 4-3. Main Interface

4.3 Material Loading

After login Handling System software, please firstly choose the experiment item and perform the sample setting, then Handling System software will automatically indicate the consumable and reagent requirement information, and reveal their corresponding loading positions. Before startup the experiment, please prepare and load the consumable and reagent according to the software prompt.

4.3.1 Load Consumables in Tip Area

Please hold the Tip holder two sides, aim its positioning gap to the positioning column, insert this side into positioning strip and press the other side downward positioning spring, as shown in figure 4-4.

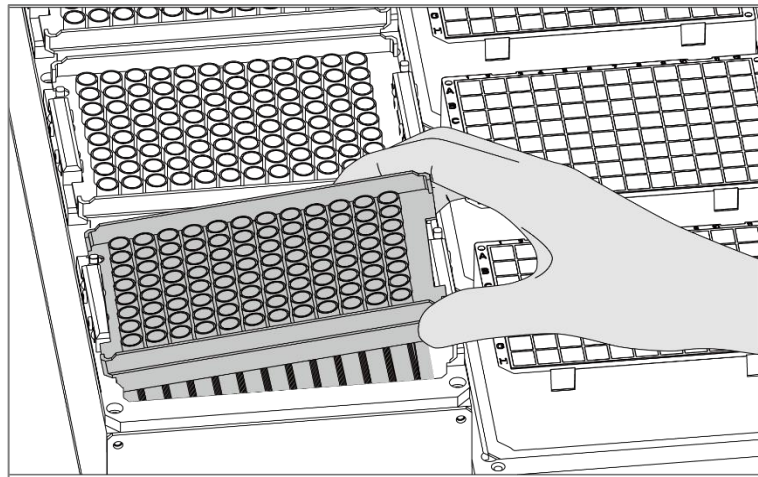

Figure 4-4. Load Tip Holder

- ⚠ Reminding:** Please load the different specification tips into the corresponding tip holder according to the prompt in system software.

 - Yellow positioning column means to load the yellow tip holder which holds 1000 μ L Tip;
 - Green positioning column means to load the green tip holder which holds 50 μ L Tip;
- ⚠ Reminding:** The tip quantity needs to meet how may the experiment requires. If Tip is not enough, Handling System will automatically estimate and prompt the user about it.

4.3.2 Load Consumables in PCR Setup and Reservation Area

Two moveable PCR loading plates can be magnetically mounted in the setup/reservation area, which could hold 24 8-strip tubes or 2 96-well plates, as shown in figure 4-5.

- ⚠ Reminding:** User could load the PCR reaction consumables according to the requirements of subsequent experiment.
- ⚠ Reminding:** The PCR tube quantity needs to meet the experimental requirements. If PCR reaction consumable is not enough when Handling System isn't scanning PCR tube, it may cause PCR setup, eluent adding failure or instrument damage.

- ❗ **Reminding:** Please load the 8-strip PCR tube vertically from left to right.
- ❗ **Reminding:** Please ensure the firm contact between the PCR tube and the bottom of PCR tube holder.
- ⚠ **Caution:** Please remove the PCR tube caps before start the experiment, otherwise it may cause reagent aliquot failure, nucleic acid extraction eluent adding failure and even result in instrument damage.

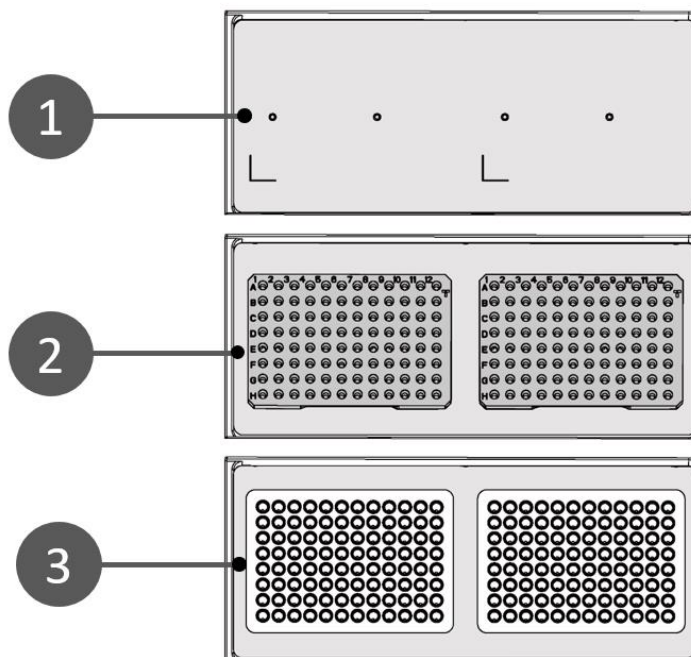

Figure 4-5. Load PCR Plate

1. Empty Setup/Reservation Area 2. Moveable PCR Loading Plate 3. 96-well PCR Plate

4.3.3 Load Consumables in Reagent and Premix Area

► Load PCR Holder

The reagent and premixing area is located within refrigeration cabin that can be automatically refrigerated at low temperature (4°C~8°C) after startup. Three reagent/premix bottle holders can be loaded from the cabin inlet and ranks from left to right as 1#, 2# and 3#, as shown in figure 4-6.

Reagent and Premixing area: Holder 1# and 2# are used for placing PCR reagent, while holder 3# is capable of holding 6 premixing bottles for premixing PCR reagent.

❗ **Reminding:** Please insert the reagent/premix bottle into the bottom of holder and push the holder into the refrigeration cabin through its inlet.

⚠ **Caution:** Please remove the caps of reagent/premix bottles before start the experiment, otherwise, it may result in experiment failure and damage the pipetting device.

⚠ **Caution:** Please unfreeze all the reagent components and premix it totally before loading them. Otherwise, it may decrease the pipetting accuracy, damage the pipetting device and even result in an ineffective experiment.

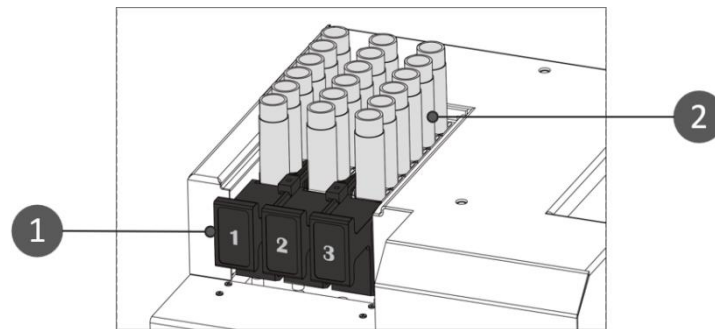

Figure 4-6. Load Reagent/Premixing Bottle and Holder

1. Reagent/Premixing Bottle Holder

2. Reagent/Premixing Bottle

► Load PCR Reagent Trough

When Handling System aliquots reagents, the user could load a PCR reagent trough where could hold enough reagents for, maximally, eight 96-well PCR plates aliquoting reagents. The user should load connecting holder first in the reagent and premixing area and then place PCR reagent trough upon the connecting holder, as shown in figure 4-7.

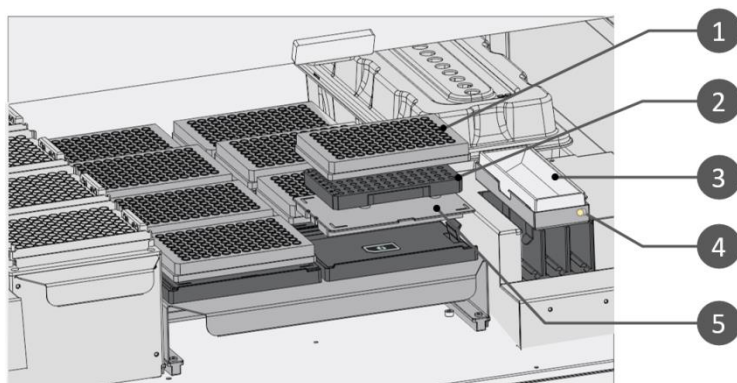

Figure 4-7. Load PCR Reagent Trough and 96-well PCR Plate

- | | | |
|------------------------------|-------------------------|-----------------------|
| 1. 96-well PCR Plate | 2. PCR Loading Plate | 3. PCR Reagent Trough |
| 4. Reagent Connecting Holder | 5. PCR Connecting Plate | |

► **Load consumables in Eluent Area**

► **Load 96-well PCR Plate**

When Handling System aliquots reagents, the eluent area could be switched into the mode of loading PCR consumables, as shown in figure 4-7. User should load PCR connecting plate in eluent area and then place PCR loading plate upon connecting plate. Lastly, load 96-well PCR plate on PCR loading plate and in eluent area could load six 96-well PCR plates.

► **Load 1mL DWP**

In light of loading number, the user could, in sequence, load 1mL 96-well DWP with eluent loaded to eluent area where is capable of holding six 1mL 96-well DWPs with their triangle notch located in bottom-left corner, as shown in figure 4-8.

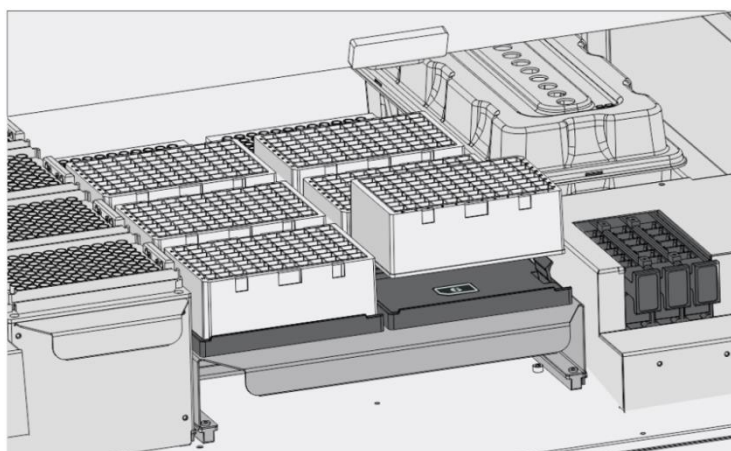

Figure 4-8. Load 1mL 96-well DWP

► Load 3mL DWP

The user should load 3mL DWP connecting plate first to eluent area before loading 3mL 48-well DWP with eluent loaded to eluent area and then, according to the loading number, place 3mL DWP upon the connecting plate with triangle notch located in bottom-right corner. In eluent area could load six 3mL DWPs, as shown in figure 4-9.

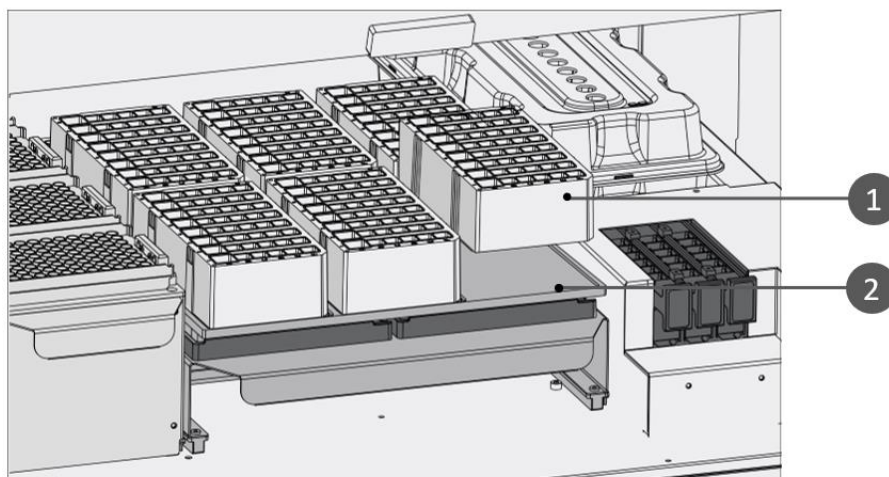

Figure 4-9. Load 3mL 48-well DWP

1. 3mL DWP

2. 3mL DWP Connecting Plate

5. Handling System Software Operation

This section introduces the basic functions of Handling System software. User only needs to choose the experiment items and complete the sample settings. Handling System will automatically complete the nucleic acid detection pre-processing works, such as reagent and nucleic acid pipetting, separation, adding, etc.



5.1 Main Interface

After the user logs in the system software, the touch screen automatically displays the system software main interface which is composed of menu bar, main display area, toolbar, information area and shortcut operation bar, as shown in figure 5-1.



Figure 5-1. Main Interface

1) Menu Bar





The menu bar is consisted of <  **Experiment Preparation** >, <  **Experiment Monitoring** > and <  **System Settings** >, which are used to call corresponding interface.

2) Main Display Area

This area displays <  **Experiment Preparation** > interface by default. User could click any tab in the menu bar and the main display area will display the corresponding concrete content of the selected tab.





3) Toolbar

The system software toolbar consists of following five keys:

- <  **UV** >: User could click this key to perform UV disinfection for Handling System.
- <  **Temperature** >: User could click this key to view the temperature status of the reagent cabin.
- <  **N.P** >: User could check the negative pressure status in the experiment cabin.
- <  **Reset** >: User could click this key to reset all components of Handling System.
- <  **About** >: User could click this key to view the current system version information of Handling System.

4) Information and Shortcut Operation Bar

The information and shortcut operation bar displays the current system status of the Handling System, including prompt information, login user account and system time; At the same time, this bar also includes three shortcut operation keys.

-  **Prompt**: The white icon represents the normal system status. However, this icon will turn yellow or red when a certain system error occurs, and the corresponding prompt or fault information will be shown at its right side.
-  **User Account**: Displays the currently logged-in user account of Handling System.
- **System Time**: Displays the current system time of Handling System.
- <  **Start** >: User could click this key to start running the current experiment.
- <  **Stop** >: User could click this key to stop running the current experiment.
- <  **Shutdown** >: User could click this key to shut down Handling System.

5.2 Experiment Preparation





After the user logs in Handling System, the main display area displays <  **Experiment Preparation** > by default, as shown in figure 5-2. The experiment preparation interface consists of  **Items**,  **Samples** and  **Reagents Consumables** three columns.



Figure 5-2. Experiment Preparation Interface

5.2.1 Experiment Item

The user could click the **Item Bar** in the  **Items** column of the experiment preparation interface and choose the corresponding experiment item in the drop-down menu. User could also click < **Details** > and the system software will turn into the **Select Item** interface for selecting experiment items, as shown in figure 5-3.



Figure 5-3. Experiment Preparation – Select Item

5.2.2 Sample Settings

User could click the **Sample Qty. : 0 + 0** in **Samples** column of the experiment preparation interface and set sample quantity in the drop-down menu, as shown in figure 5-4.

- ❗ **Reminding:** User can set the **quantity of sample + the quantity of quality control and standard product** in the drop-down menu.
- ❗ **Reminding:** The quality control and standard products should be placed behind the sample in the DWP.



Figure 5-4. Experiment Preparation – Sample Quantity Settings

User can also click **< Details >** in the **Samples** column, the software will pop up the sample settings interface, as shown in figure 5-5. The sample settings interface consists of a sample area and **< Sample No. >**, **< Detection Item >**, **< Quality Control >**.

When the user proceeds reagent aliquot, the **Samples** column under experiment preparation interface only displays **Sample Qty.: 0 + 0** and **PCR Plate Qty.: 1** and the user can set the quantity of sample and PCR plate.

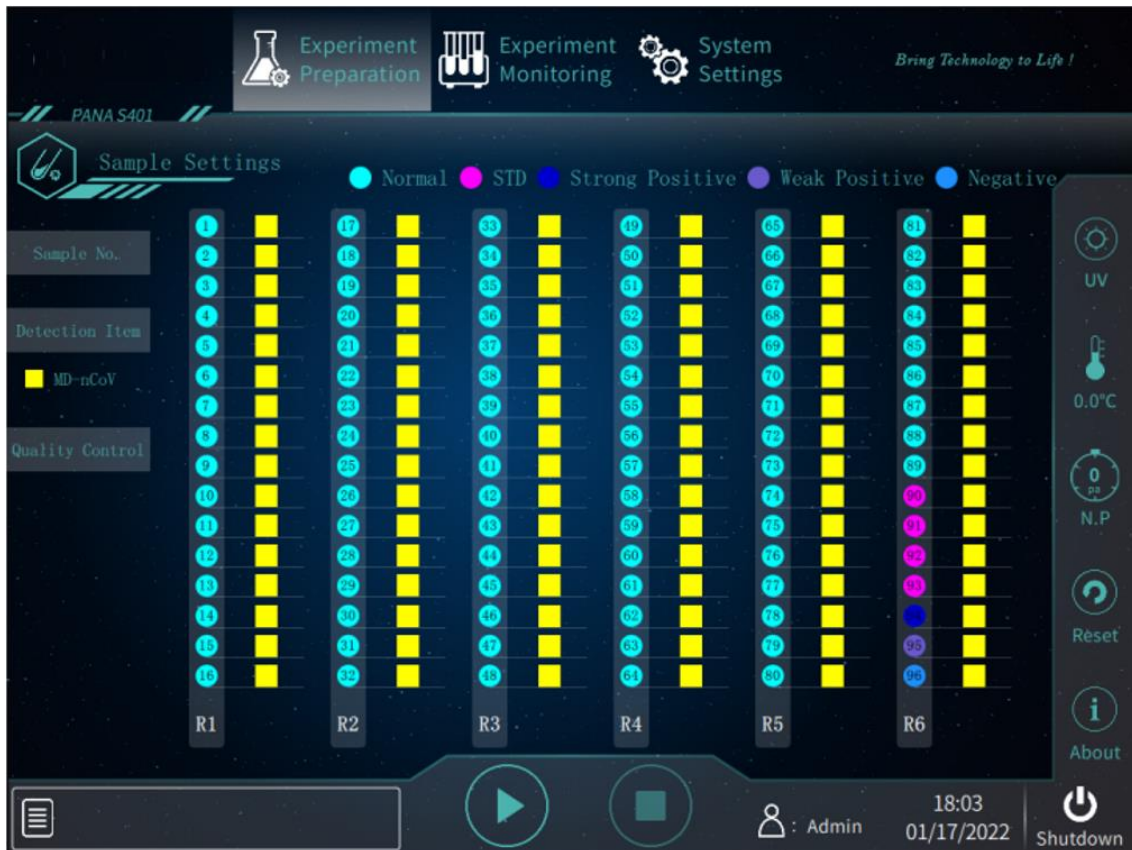

Figure 5-5. Experiment Preparation - Sample Settings Interface

► Sample Area:

The sample area is divided into six columns, with 16 samples per column. User can select one or more samples and click 3 subtabs to perform the sample settings for the selected sample(s).

⚠ Reminding: The sample number of each sample is displayed in the circle icon, the circle icon color of each sample represents corresponding sample type and the square icon color of each sample represents corresponding detection item.

- The No. 1 to No. 16 nucleic acid extraction eluent samples in the R1 column are from DWP 1 and will be transfer to the 1st and 2nd row of 96-well PCR plate/ the 1st and 2nd 8-strip PCR tubes;
- The No. 17 to No. 32 nucleic acid extraction eluent samples in the R2 column are from DWP 2 and will be transfer to the 3rd and 4th row of 96-well PCR plate/ the 3rd and 4th 8-strip PCR tubes;
- The No. 33 to No. 48 nucleic acid extraction eluent samples in the R3 column are from DWP 3 and will be transfer to the 5th and 6th row of 96-well PCR plate/ the 5th and 6th 8-strip PCR tubes;

- The No. 49 to No. 64 nucleic acid extraction eluent samples in the R4 column are from DWP 4 and will be transfer to the 7th and 8th row of 96-well PCR plate/ the 7th and 8th 8-strip PCR tubes;
- The No. 65 to No. 80 nucleic acid extraction eluent samples in the R5 column are from DWP 5 and will be transfer to the 9th and 10th row of 96-well PCR plate/ the 9th and 10th 8-strip PCR tubes;
- The No. 81 to No. 96 nucleic acid extraction eluent samples in the R6 column are from DWP 6 and will be transfer to the 11th and 12th row of 96-well PCR plate/ the 11th and 12th 8-strip PCR tubes.

► **Sample No. Subtab:**

User could click < **Sample No.** > subtab to set the sample number for the select sample(s) in the **Sample No.**, as shown in figure 5-6.



Figure 5-6. Experiment Preparation - Sample Settings Interface - Sample No. Subtab

❗ **Reminding:** User could select more than one samples, enter the initial sample numbers in **Initial No.** input box and click < **Auto Increment** >, so Handling System software will

number the selected samples according to their serial number automatically.

► **Detection Item Subtab:**

If there are multiple detection items of the current experiment item, user could click < **Detection Item** > subtab to set the detection item, as shown in figure 5-7. User could select multiple samples in the sample area and select the corresponding detection items for the selected samples.



Figure 5-7. Experiment Preparation - Sample Settings Interface - Detection Item Subtab

► **Quality Control Subtab:**

User could click < **Quality Control** > subtab to set the sample type of the selected samples as standard/QC samples, as shown in figure 5-8.



Figure 5-8. Experiment Preparation - Sample Settings Interface - Quality Control Subtab

5.2.3 Reagents/Consumables Settings

a. Eluent Transfer

When proceeds eluent transfer, the user can click < Standard DWP > under <  **Reagent/Consumables** > and select the DWP from drop-down menu. User could also click < **Details** > to make some settings in the pop-up interface, as shown in figure 5-9.

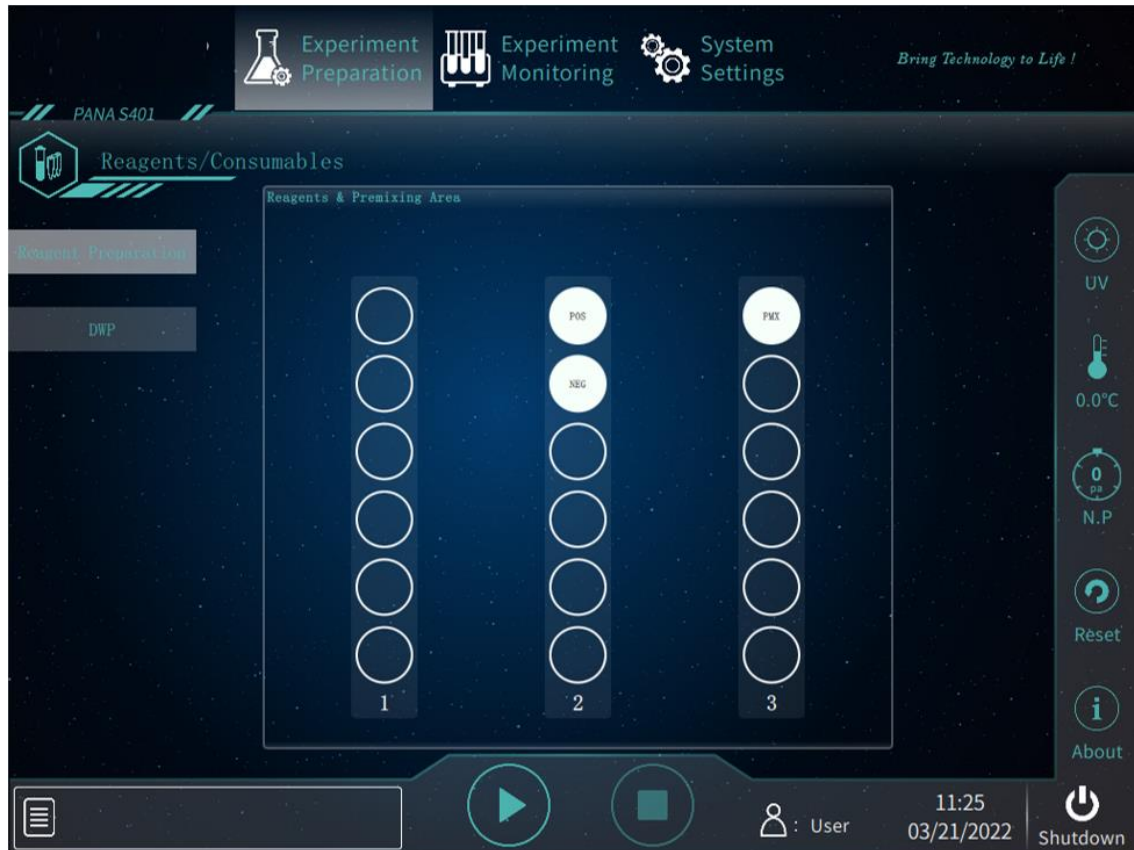

Figure 5-9. Experiment Preparation -Sample Settings Interface -Reagents/Consumables Settings

The interface of < **Reagent/Consumables** > is composed of < **Reagent Preparation** > and < **DWP** >.

- ▶ < **Reagent Preparation** >: Handling System software can automatically analyze the requirement information of reagent and consumable according to the settings of < **Item** > and < **Samples** >. Please prepare the corresponding loading holder, reagent bottle, premix bottle and reagent group according to the prompts from the tab of reagent preparation, as shown in figure 5-10.

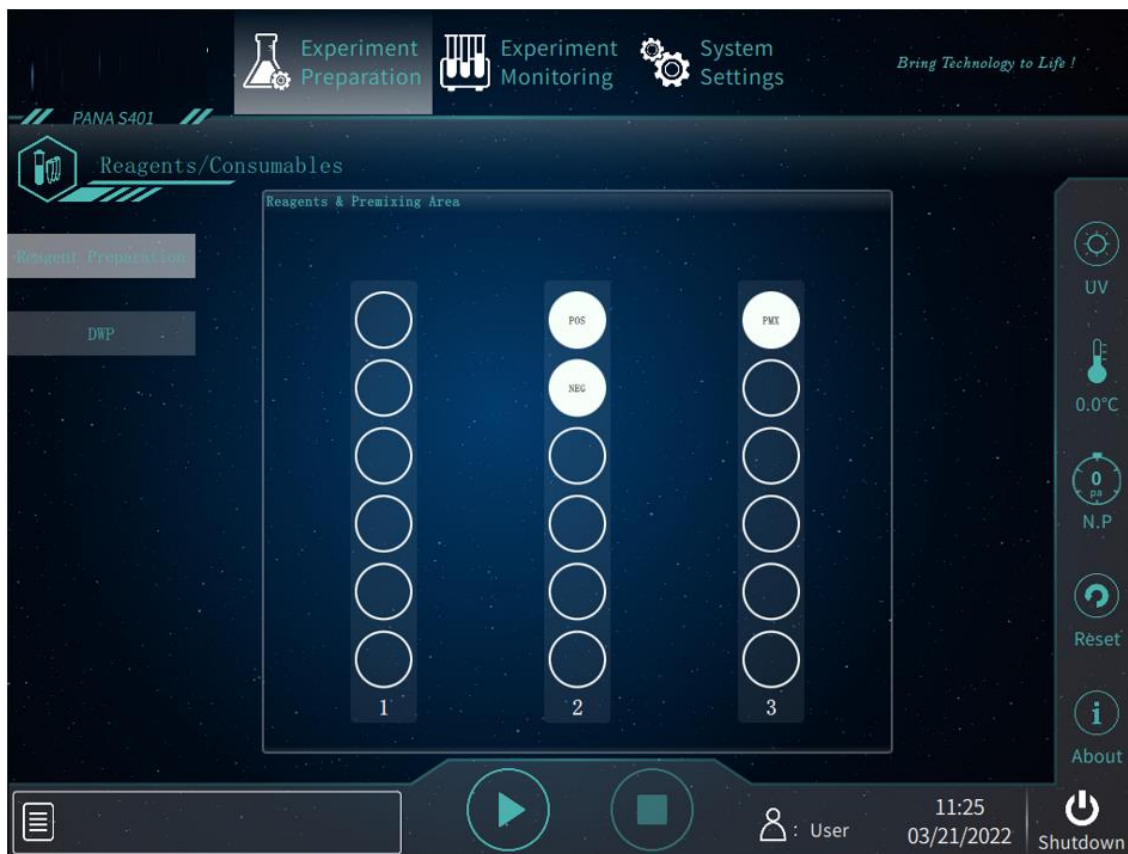

Figure 5-10. Experiment Preparation -Reagent/Consumables - Reagent Preparation

- ▶ **<DWP>**: The user can click **<DWP>** to select DWP that the experiment needs in the pop-up DWP interface where can view DWP information, as shown in figure 5-11.



Figure 5-11. Experiment Preparation -Reagent/Consumables – DWP

The user can select the DWP and click < **Delete** > to delete the selected DWP and < **Confirm** > to set the selected DWP for experiment. If there is no applicable DWP, the user can click < **New** > to create a DWP, as shown in figure 5-12.

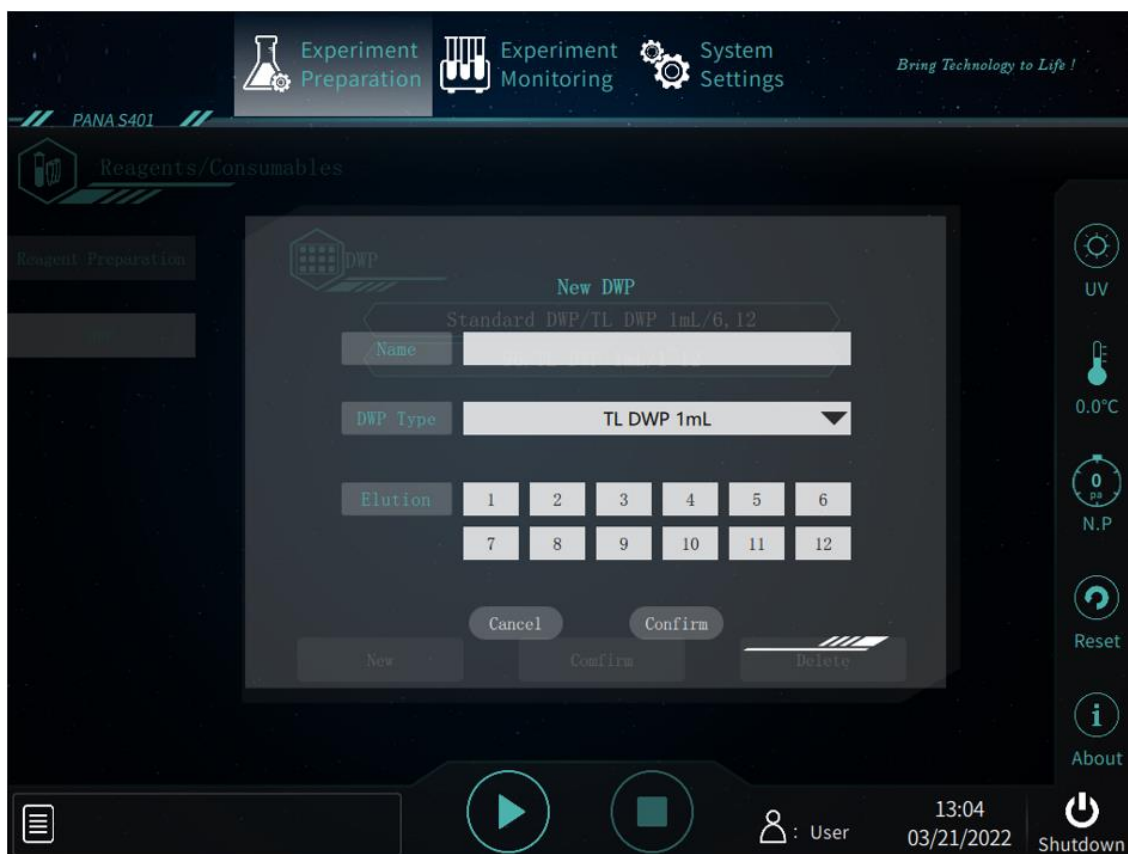

Figure 5-12. Experiment Preparation -Reagent/Consumables - New DWP

The user can edit DWP information in the interface of new DWP. There could enter DWP name in the name box, select a DWP Type in the drop-down list and set DWP elution column in the tab of elution. < **Confirm** > is for saving the edit and < **Cancel** > is for abandoning the edit.

⚠ Reminding: After starts the experiment, Handling System will automatically scan the barcode on Tip, DWP and PCR consumables. If the consumables quantities and locations are not matched with the setting information of < **📄 Samples** >, Handling System software will automatically prompt user to check again.

b. Reagent Aliquot

When proceeds reagent aliquot, the user could click < **Details** > from < **📄 Reagent/Consumables** > under the interface of experiment preparation and set the information about reagent in the pop-up window, as shown in figure 5-13.

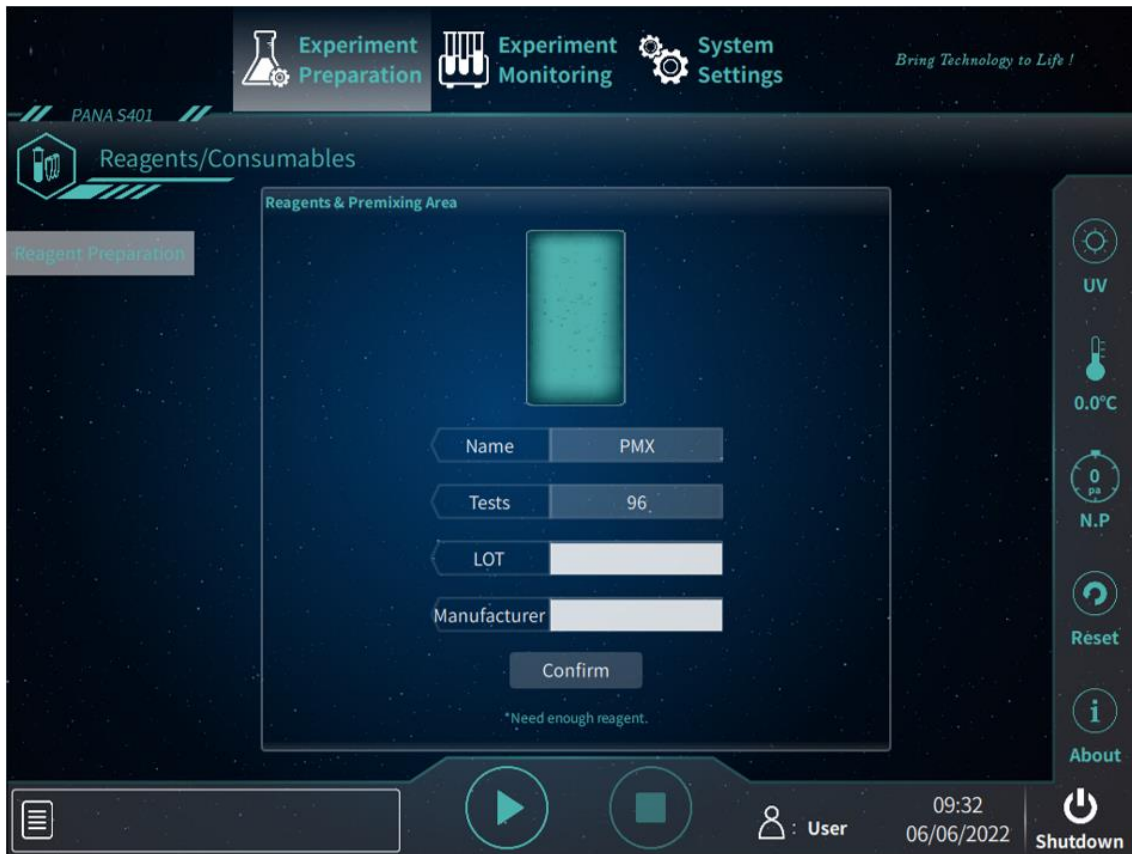







Figure 5-13. Experiment Preparation -Reagent/Consumables - Reagent Preparation

5.3 Start the Experiment

After completes all the settings in experiment preparation interface, user could click the shortcut key on the system software interface to start running the experiment. In addition, user could also pause or stop the currently running experiment during the experiment progress.

- ▶ <  **Start** >: User could click this key to start running the current experiment.
- ▶ <  **Pause** >: The <  **Start** > will switch to <  **Pause** > after starts up the experiment and the user could click this shortcut key to pause the currently running experiment.
- ▶ <  **Stop** >: User could click this key to stop the currently running experiment.

5.4 Experiment Monitoring

After starts the experiment, Handling System software will automatically turn into the experiment monitoring interface, as shown in figure 5-14.

- ❗ **Reminding:** Handling System covers normal mode (including 1mL and 3mL DWP) and

reagent aliquot mode. The experiment monitoring interface is automatically switched according to the experiment operation mode and here only takes normal mode(1mL DWP) as an example for introduction. Meanwhile, the reagent aliquot mode could be referred to normal mode.



Figure 5-14. Experiment Monitoring Interface

The layout of experiment monitoring interface corresponds to the experiment cabin arrangement. User could timely monitor the experiment operation, running status, experiment progress and remaining time of Handling System.

- The experiment progress circle at top right corner of the interface is composed of four parts: **Premix**, **Aliquot**, **PCR Setup** and **Eluent Reserve**, that are represented by different colors accordingly. While the experiment is running, the cursor of the corresponding step will continuously flash, indicating that this is the currently running step. The remaining time of the current experiment will be displayed in middle of the experiment progress circle. The experiment progress circle can be pressed to zoom in, as shown in figure 5-15.



Figure 5-15. Experiment Monitoring Interface - Experiment Progress Circle

- ▶ **Tip Area:** It corresponds to the tip holder in the experiment cabin and displays the remaining tip quantity and locations.
- ▶ **PCR Area:** It corresponds to the setup/reservation area in the experiment cabin and displays the real-time position and status of pipetting device in the process of PCR setup and eluent reservation.
- ▶ **DWP Area:** It corresponds to the eluent area in the experiment cabin and displays DWP's real-time position and status when loads nucleic acid eluent and PCR plates' position and status in the process of reagent aliquot.
- ▶ **Reagent & Premixing Area:** It corresponds to the reagent and premixing area in the experiment cabin and displays the real-time position and status of loading holder and reagent & premixing bottles in the process of reagent transferring and premixing. Moreover, it displays reagent trough status and reagent information when Handling System aliquots reagent.
- ⚠ **Reminding:** There are different colors labeled for the Tip area, PCR area, DWP area, reagent and premixing area representing the different sample and consumable status.

5.5 System Settings

User could click <  **System Settings** > in the menu bar to enter the system settings interface. The system settings interface consists of **Maintenance** and **Settings** two tabs and Handling System displays the **Maintenance** subtab by default, as shown in figure 5-16.

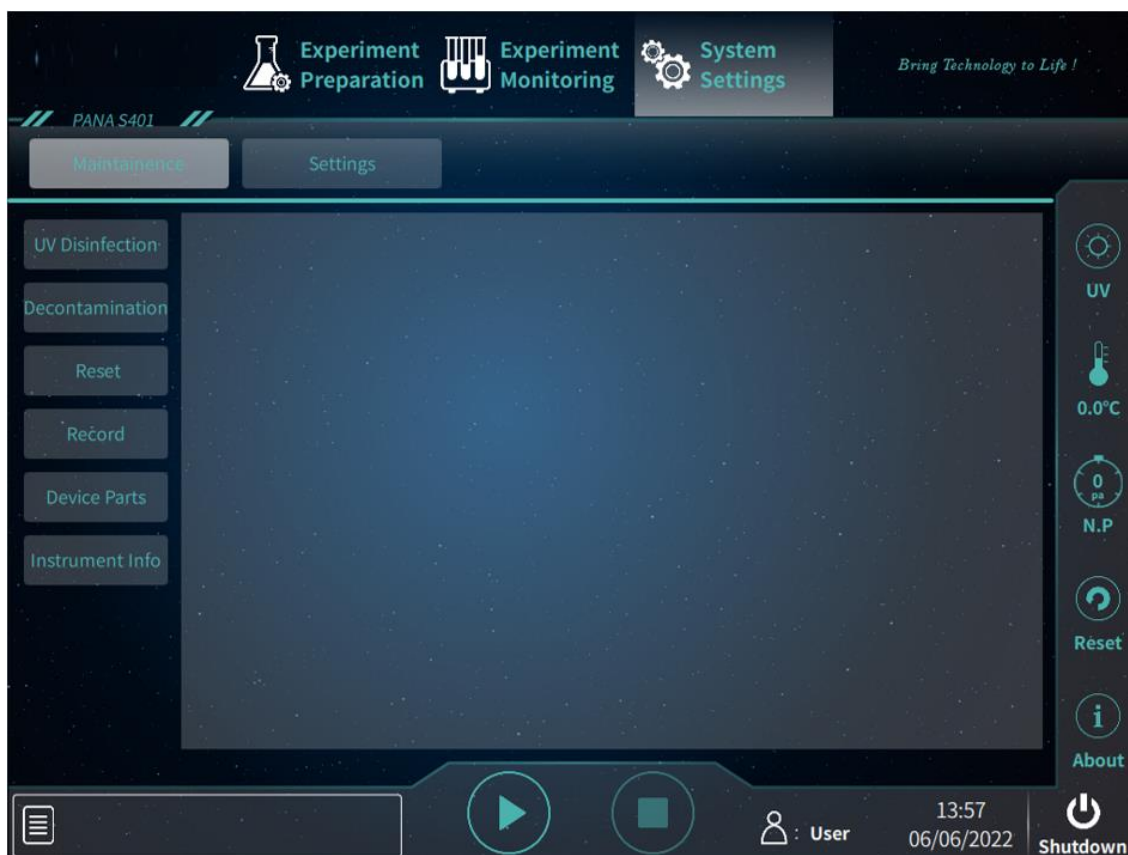



Figure 5-16. System Settings Interface – Maintenance Tab

5.5.1 Maintenance

The **Maintenance** tab consists of < **UV Disinfection** >, < **Decontamination** >, < **Reset** >, < **Record** >, < **Device Parts** > and < **Instrument Info** > six function keys, as shown in figure 5-16.

- ▶ < **UV Disinfection** >: Click this function key, Handling System software will automatically pop up the UV disinfection window where user could click < **Start** > or < **Stop** > to start or stop the UV disinfection, as shown in figure 5-17.

 **Reminding:** User could check the **Auto Shutdown** check box, Handling System will automatically shutdown after UV disinfection.

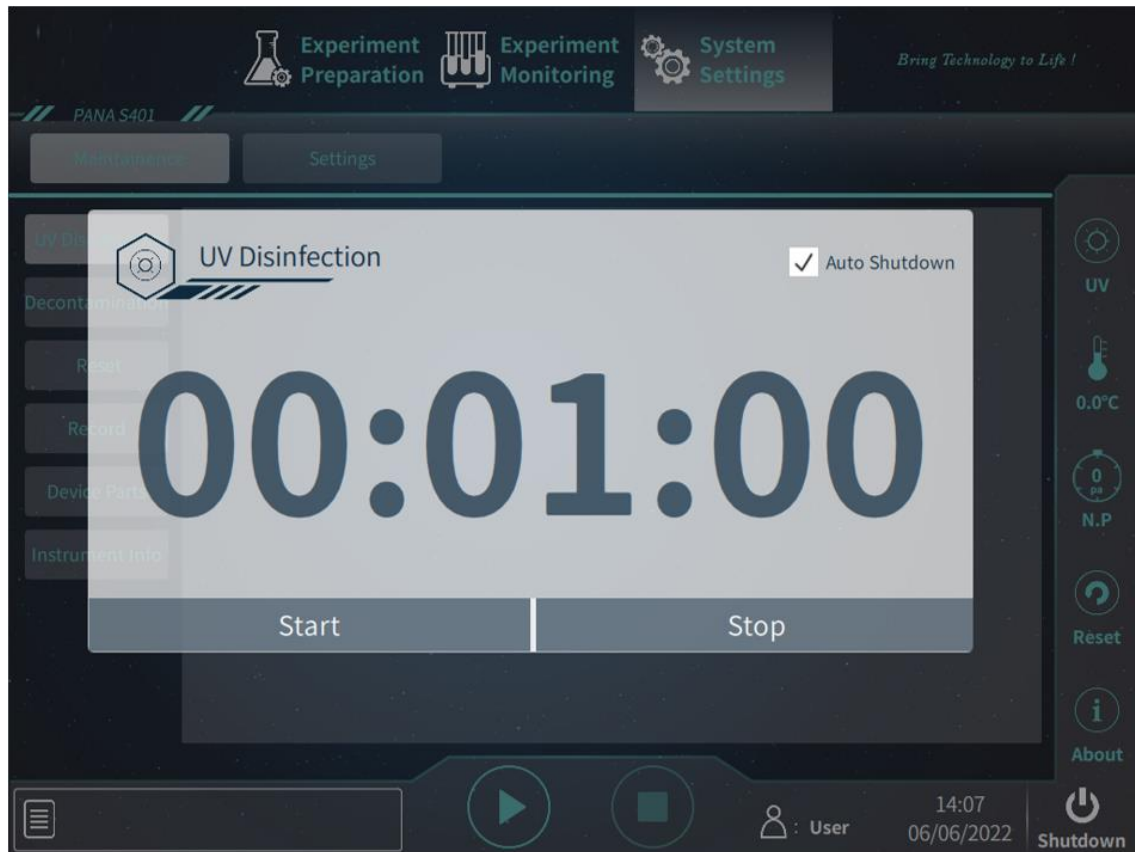

Figure 5-17. System Settings Interface – Maintenance Tab – UV Disinfection

- ▶ < **Decontamination** >: By clicking this function key, Handling System software will automatically pop up the decontamination window, where user could click < **Start** > or < **Stop** > to start or stop the decontamination, as shown in figure 5-18.
- ❗ **Reminding:** User could check the **UV Disinfection** box, Handling System will perform the UV disinfection before decontamination.
- ❗ **Reminding:** User could check the **Auto Shutdown** check box, Handling System will automatically shutdown after decontamination.

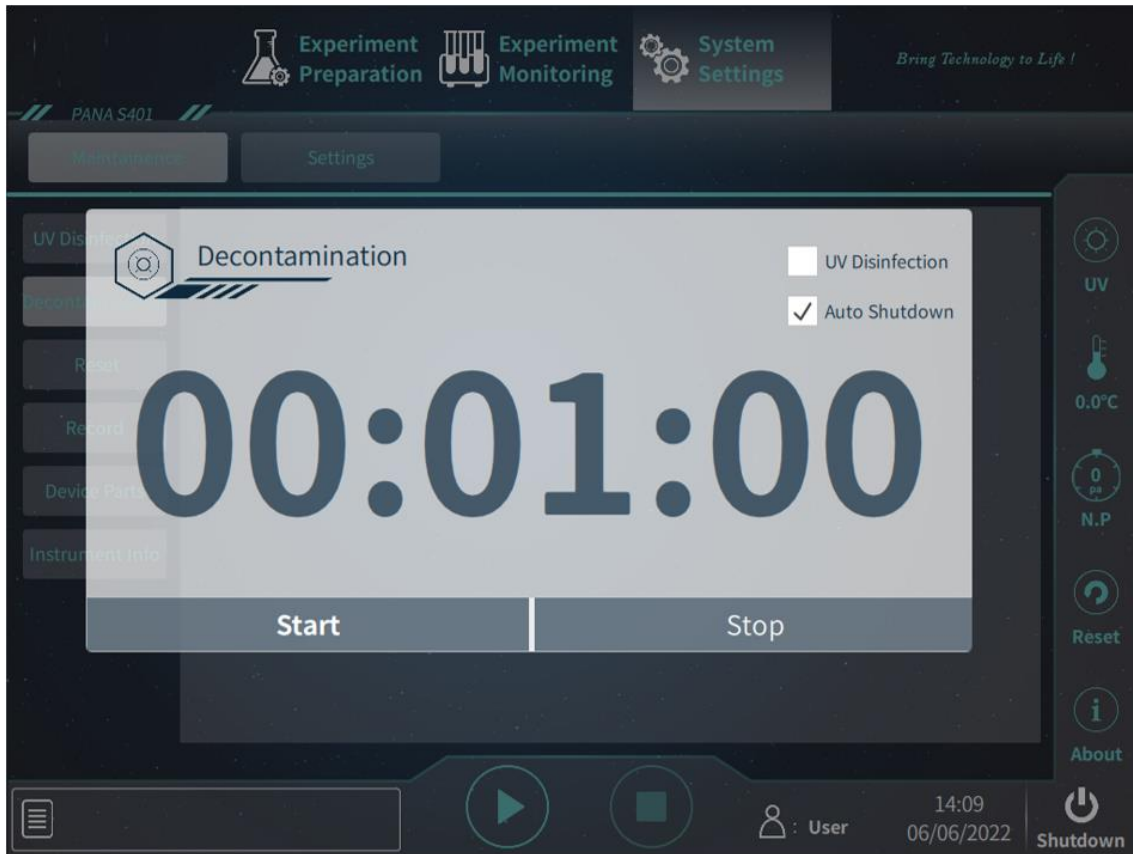

Figure 5-18. System Settings Interface – Maintenance Tab – Decontamination

- ▶ **< Reset >**: If the experiment program is paused or stopped while running, user could click this function key to reset Handling System.
- ▶ **< Record >**: User could click this function key to view the experiment records table where could view all 27 experiment records by clicking **< Up >** and **< Down >**, as shown in figure 5-19. The user can view any record by double-click on it and can click **< Search >** to set the start and end date after selects the experiment item in the pop-up interface so as to search the records. **< Export >** is for exporting record to LIS folder.

PANA S401

Experiment Preparation Experiment Monitoring System Settings

Bring Technology to Life!

Maintenance Settings

UV Disinfection

Decontamination

Reset

Record

Device Parts

Instrument Info

Search Up Down Page:1/3 Export

No.	Time	Item	Amount	Status
1	2021/12/09 16:15:07	MD-nCoV	96	Unfinish
2	2021/12/09 16:14:24	MD-nCoV	96	Unfinish
3	2021/12/09 16:06:16	MD-nCoV	96	Unfinish
4	2021/12/09 15:56:59	MD-nCoV	4	Finish
5	2021/12/09 15:45:57	MD-nCoV	4	Unfinish
6	2021/12/09 15:41:39	HBV	1	Unfinish
7	2021/12/09 09:58:12	TL-HBV	62	Unfinish
8	2021/12/08 17:44:33	DA-nCoV	30	Unfinish
9	2021/12/08 17:43:21	DA-nCoV	30	Unfinish

UV 0.0°C

0 pp N.P.

Reset

About

14:10 06/06/2022 Shutdown

User

Figure 5-19. System Settings Interface – Maintenance Tab – Record

- ▶ **< Device Parts >**: User could click this function key to view UV lamp and HEPA filter service duration, as shown in figure 5-20. Both UV lamp and HEPA filter service duration are 1000 hours, maximally. If it serves out of 1000 hours, system will remind user to change the corresponding parts with a pop-up window. Handling System could count down from the beginning after user changes the parts and clicks reset button.

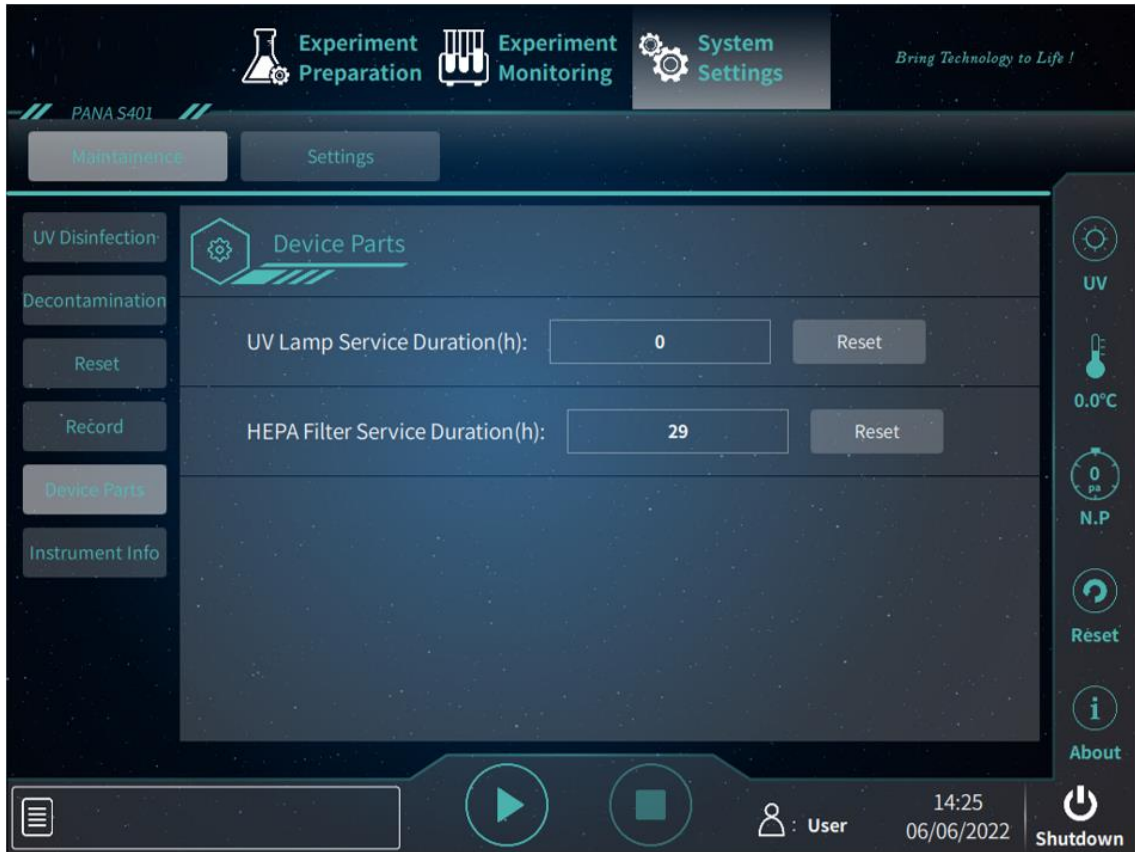

Figure 5-20. System Settings Interface – Maintenance Tab – Device Parts

- ▶ **< Instrument Info >**: User could click this function key to view the instrument's name, S/N, Model, etc., as shown in figure 5-21.



Figure 5-21. System Settings Interface – Maintenance Tab – Instrument Info

5.5.2 Settings

The **Settings** tab consists of *< Program >*, *< Visual Inspect >*, *< Decontamination >*, *< UV Disinfection >*, *< Enhancements >* and *< Language >* six function keys, as shown in figure 5-22.

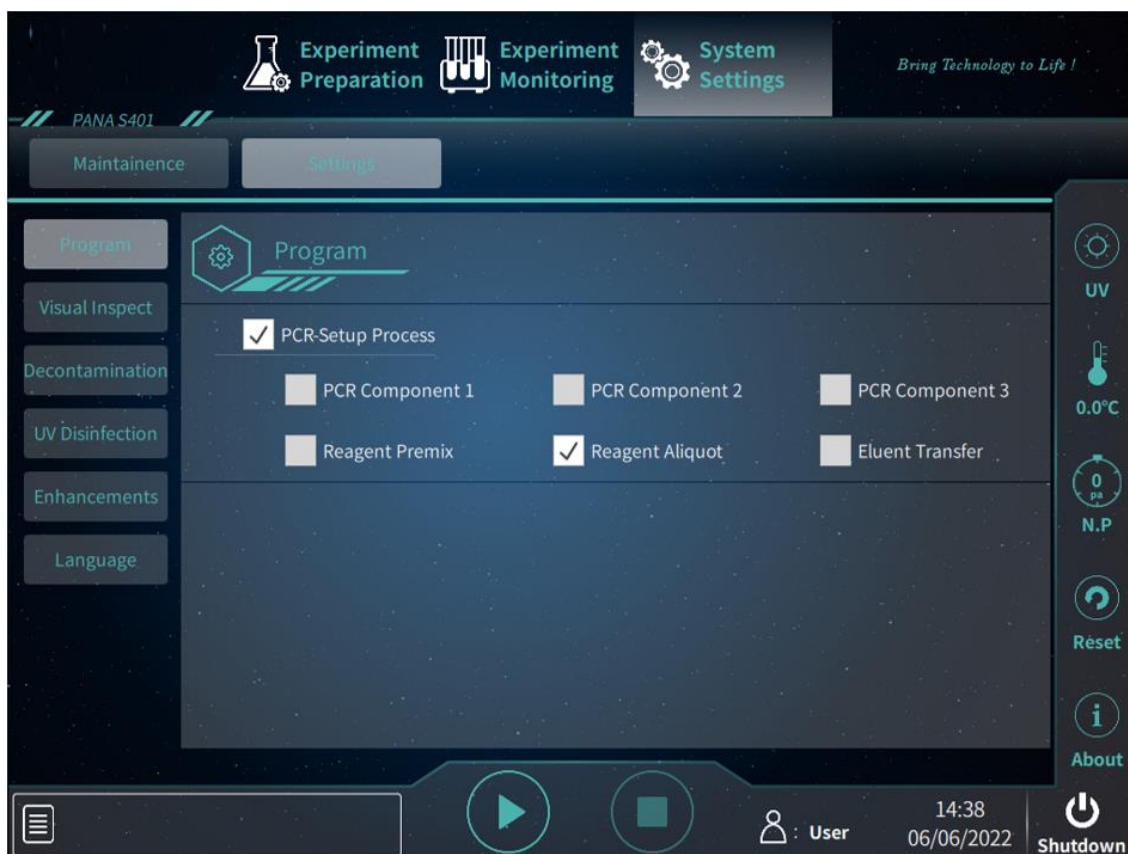

Figure 5-22. System Settings Interface – Settings Tab – Program

- ▶ **< Program >**: User could click this function key to set the experiment program steps. User could check the corresponding check box to select the step(s) included in the experiment program, as shown in figure 5-22.
- ▶ **< Visual Inspect >**: User could click this function key to set the visual inspect steps during experiment in order to inspect the quantity of tips, DWPs and PCR tubes and read the barcode. User could check the corresponding check box to select the step(s) included in the experiment program, as shown in figure 5-23.
- ⚠ **Reminding**: User could check the **Select All** check box to include all the visual inspect step in the experiment program.



Figure 5-23. System Settings Interface – Settings Tab – Visual Inspect

- ▶ < **Decontamination** >: User could click this function key to set the decontamination parameters, including **Fan running Duration**, **Fan Speed** and **UV Disinfection Duration**, as shown in figure 5-24.
- ❗ **Reminding:** The UV disinfection duration and fan running duration can be set from 1 to 240 minute(s).

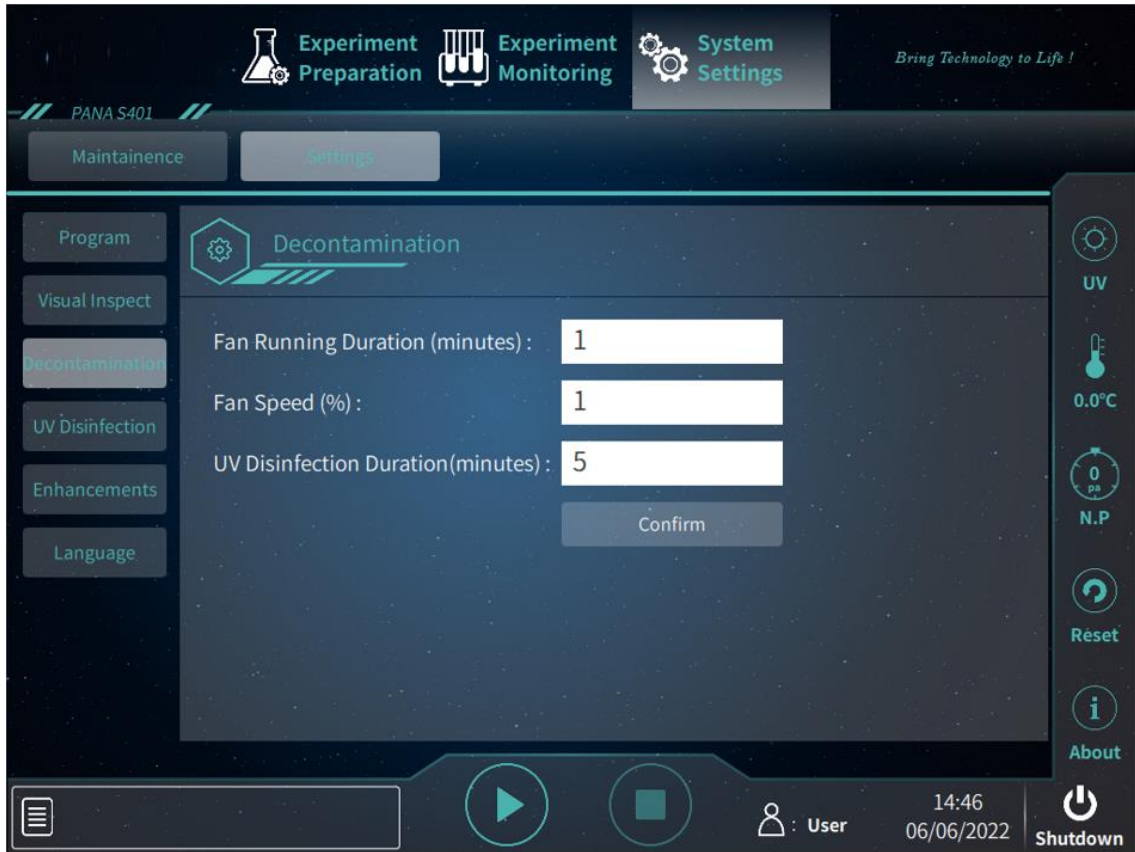

Figure 5-24. System Settings Interface – Settings Tab – Decontamination

- ▶ **< UV Disinfection >**: User could click this function key to set the UV disinfection duration which could be set as 1-240 minute(s), as shown in figure 5-25.

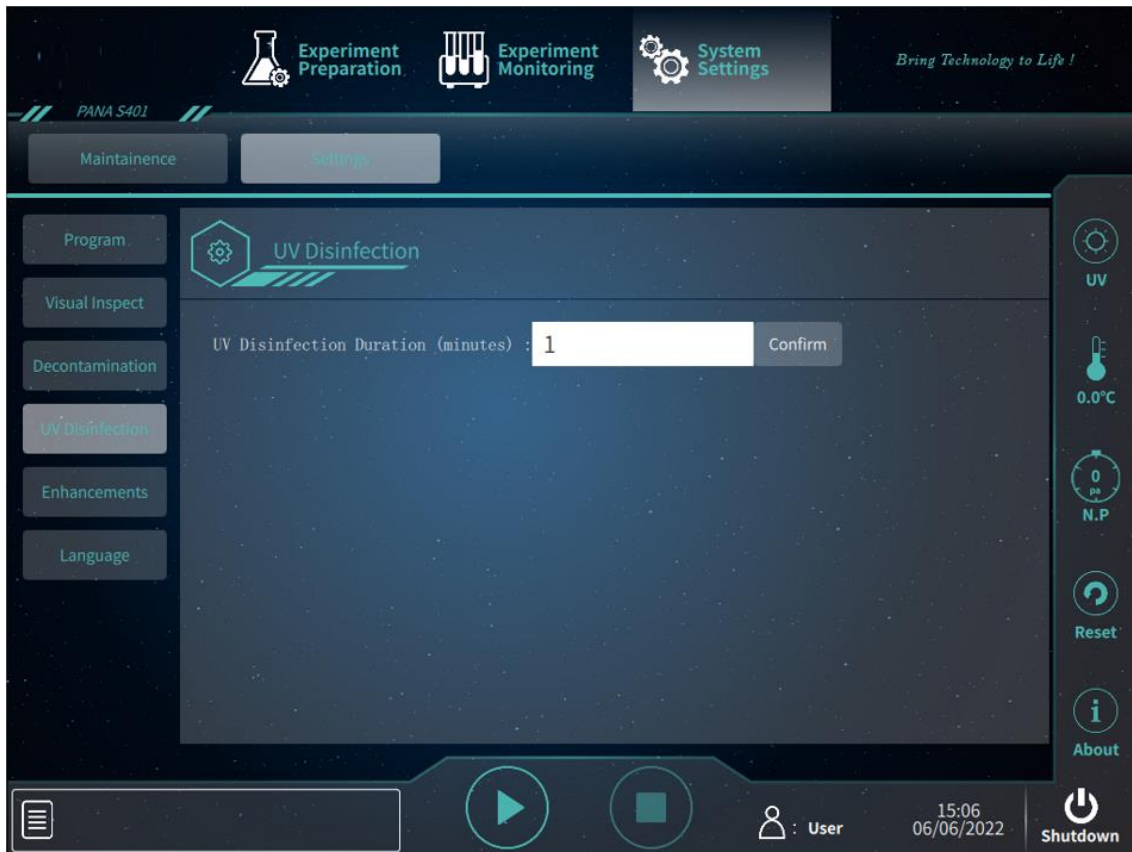



Figure 5-25. System Settings Interface – Settings Tab – UV Disinfection

- ▶ **< Enhancements >**: This tab consists of **Laboratory Information System** and **Reagent Aliquot**, as shown in figure 5-26.
- **Laboratory Information System**: After user inputting the self-defining instrument number, checking laboratory information system box and entering the server address, the experiment information can be directly imported to laboratory information system where user could check out sample information.
 - ❗ **Reminding**: When user checks laboratory information system box, the top-right corner of Handling System shows  that means laboratory information system is connected while  means that is unconnected.
- **Reagent Aliquot**: Handling System steps into reagent aliquot mode after user checks this box, meanwhile, the interface of **< Experiment Preparation >** and **< Experiment Monitoring >** will also switch into reagent aliquot mode. There could load 8 PCR plates for every reagent aliquot experiment.

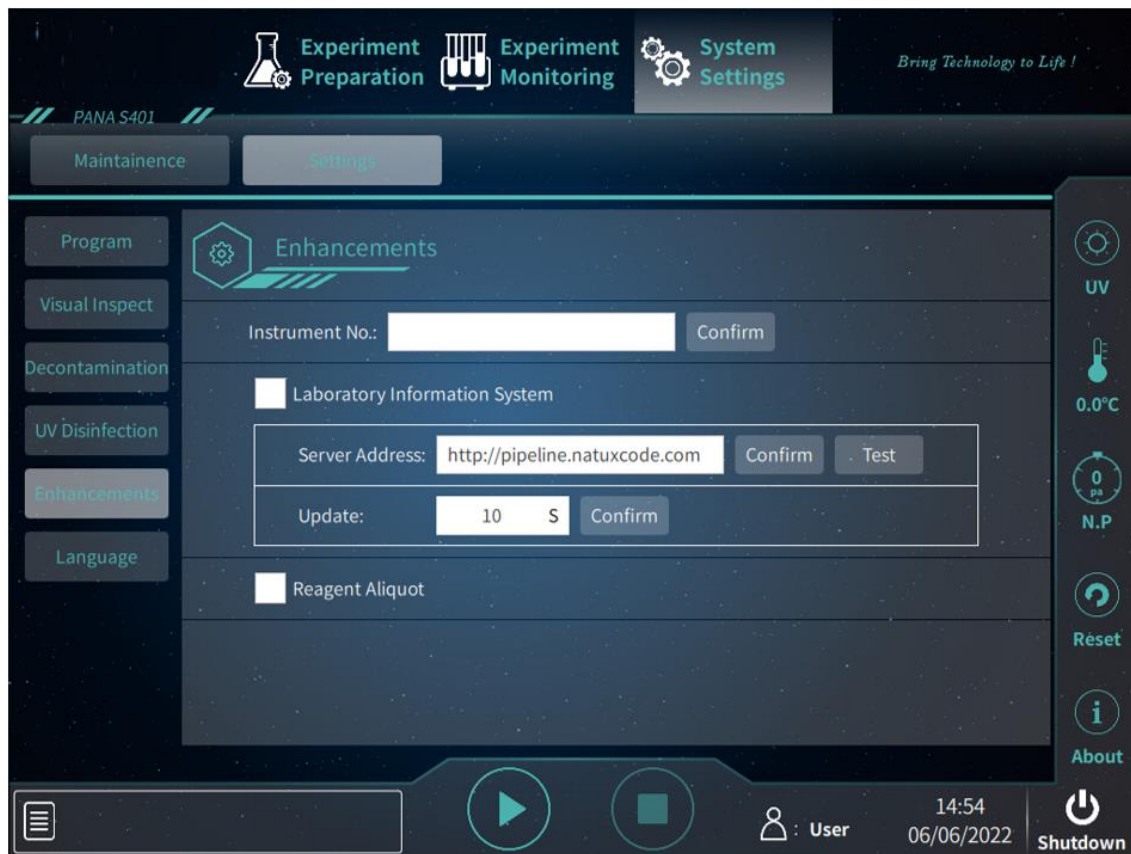

Figure 5-26. System Settings Interface – Settings Tab – Enhancements

- ▶ **< Language >**: Handling System provides Chinese and English two software languages. User could click this function key to select the system language by checking corresponding check box, as shown in figure 5-27.
- ❗ **Reminding**: when the user switches the language from Chinese to English, however, the item names still keep Chinese version besides the experiment status in experiment record and the summaries generated under Chinese system.

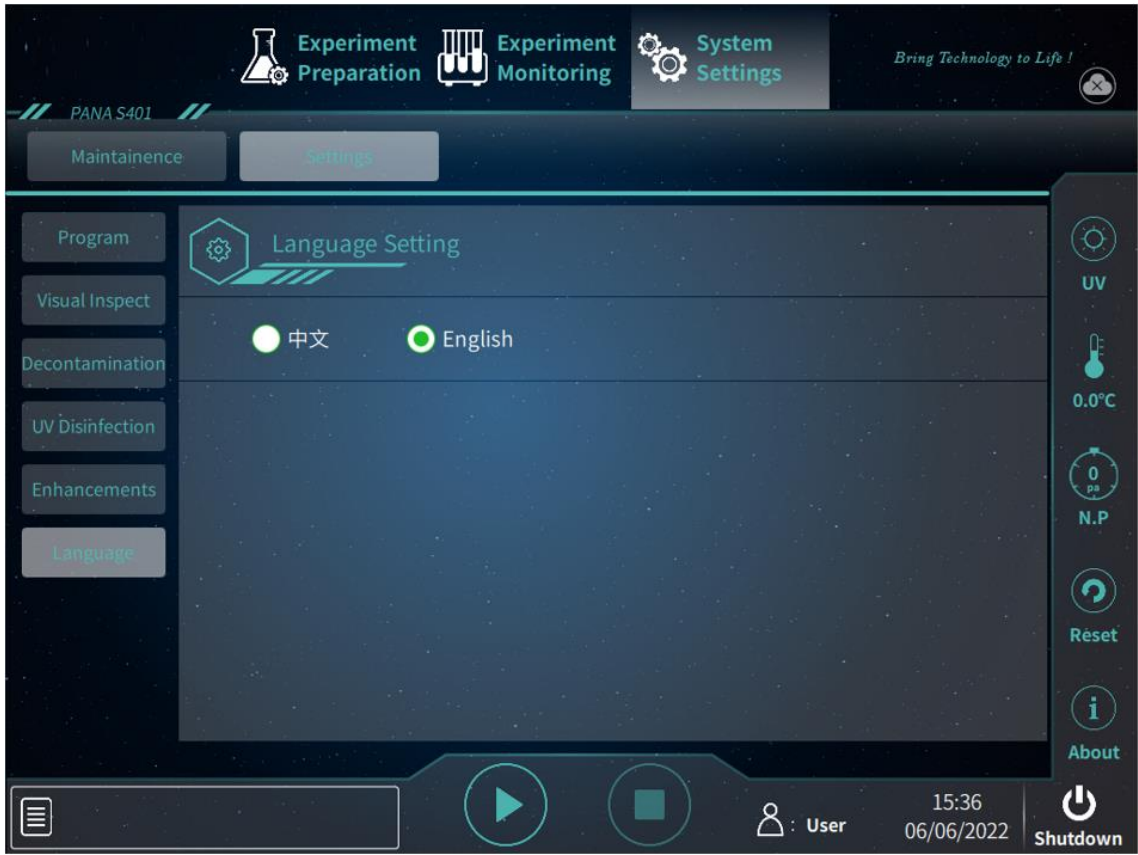







Figure 5-27. System Settings Interface – Settings Tab – Language

6. Instrument Maintenance and Cleaning

Under proper use condition, Handling System requires a little maintenance. However, the instrument should be cleaned and maintained regularly as of the long time and constant use after experiment every time. Before cleaning the instrument, please carefully read this section to ensure a proper cleaning and maintenance so as to prolong the instrument service life.

6.1 Instrument Cleaning Operation Instructions

-  **Prohibit:** Never clean or maintain the instrument when it is running.
-  **Prohibit:** Never pour water or other solutions into any components inside the experiment cabin. Fluids can cause electrical shock when the instrument is electrified.
-  **Prohibit:** Never use the detergent or disinfectant which is easy to react chemically with the instrument material or the parts. This may cause danger.
-  **Caution:** Ethanol is a flammable and volatile, its exposure may irritate eyes, skin and respiratory tract and even lead to central nervous system hypofunction and liver damage. Please wear appropriate protective goggles, suit and gloves, when using ethanol to clean.
-  **Biohazard:** Never treat or operate any potential biohazard samples without taking any safety precautions.

6.1.1 Clean Instrument Shell

1st step: Please switch off and unplug the instrument;

2nd step: Please clean the instrument shell with a piece of moist and soft cloth. If needed, please clean the instrument with the mild detergent.

 **Caution:** Please do not directly spray the detergent on the instrument, which may cause malfunctions.

 **Caution:** Please do not use the strong acid, strong alkali, alcohol with concentration over 75%, organic solvent or strong decontaminant to clean the instrument shell, which may damage the shell coating.

6.1.2 Clean Touch Screen

1st step: Please switch off and unplug the instrument;

2nd step: Please gently wipe the touch screen with a piece of dry and soft cloth to clean the dust, oil or fingerprints, if which is stubborn, please use the soft cloth wet by the mild detergent instead.

 **Caution:** Please do not directly spray the detergent on the touch screen, which may cause malfunctions.

 **Caution:** Please do not use abrasive detergent or rough material to clean the instrument as they may scratch the touch screen.

6.1.3 Clean Experiment Cabin

1st step: Please open the experiment cabin, turn off and unplug the instrument.

2nd step: Please draw out the consumable loading platform and remove the Tip, DWP and PCR consumables. please comply with the relevant requirements to dispose the wasted tips and DWPs, etc.

3rd step: Please draw out the reagent/premixing holders, recycle the unspent reagent and clean up the waste reagent/premixing bottles, disassemble the droplet capture plate and take out the waste bin to keep the instrument on standby.

4th step: Please spray medical alcohol or 75% alcohol on the clean soft cloth or absorbent paper to wipe the experiment inner wall, waste bin, consumable loading platform and the guide rail and empty zone under the consumable loading platform.

5th step: Please dry the processing liquid holder and the droplet capture plate with the dry absorbent paper after sprays medical alcohol or 75% alcohol on them.

6th step: Please place where the processing liquid holder and the droplet capture plate is. Change a new waste box, start Handling System and UV Disinfection, after which is finished, the user could experiment and shut the instrument down.

 **Caution:** Please do not spray the detergent directly on the instrument, which may cause instrument fault.

 **Caution:** Please abide by the native or national laws and regulations when disposes the waste samples and contaminated materials.

6.1.4 Powerful Cleaning

The detecting object of Handling System is the biological samples with the potential danger of spreading and infecting disease. Please consider all samples, processing liquid and products as the materials with potential biohazard, which may be prevented by taking applicable safety protections. During operating the instrument, if the materials with the potential biohazard is leaked or spattered on or inside the instrument because of the unexpected reasons, please immediately disinfect the contaminated area with appropriate detergent so as to avoid the contaminant spreading and harming the operators or instruments. Please follow the below steps:

1st step: Please open the experiment cabin, turn off the instrument and unplug the power cord.

2nd step: Please clean up the contaminants or stains from contaminated parts with wet absorbent paper. If fails to clean, please use neutral detergent to clean again thoroughly.

3rd step: Please clean the contaminated parts thoroughly with the absorbent paper wet by the clean water. In order to ensure the cleaning effect, please timely replace the absorbent paper, repeat this cleaning procedures 3 times. If the contaminated parts can be taken out, please wash these parts directly with running water.

 **Reminding:** In order to guarantee a well condition for instrument, please clean the experiment cabin again as described in chapter 6.1.3 after the powerful cleaning.

6.2 Instrument Maintenance Instructions

6.2.1 Maintain Adequate Ventilation

Handling System should be used where maintains adequate ventilation to reach the precise target temperature. Please regularly check the air flow is unrestricted and other items around the instrument do not interfere with the air flow.

6.2.2 Maintain Stable Power Supply

Handling System requires a stable power supply for proper functioning. Therefore, its power supply should be checked regularly to ensure the instrument required voltage is consistent with the power supply voltage (allowable deviation $\pm 10\%$) and to ensure the rated load of receptacle is greater than or equal to the rated load requirement of instrument.

6.2.3 Maintain Instrument Clean

Contaminating the experiment cabin may influence the instrument performance and data correction. Please follow the instructions below and try to avoid the instrument contamination.

- ▶ Please clean DWP outer wall before load the DWP to the eluent area.
- ▶ Please regularly clean the operation platform so as to avoid the dirt and biohazard materials accumulation.

 **Caution:** Never load and detect the volatile reagent which may contaminate the experiment operation platform.

 **Caution:** Please unplug the instrument and cover it with soft cloth or dust bag to prevent the dust from the instrument when it's not used for a long time.

6.2.4 Replace Waste Bin

Handling System will automatically unload the waste generated during the experiment program and drop them into the waste bin through the inlet. It is requested to clean up the waste bin after the experiment.

 **Caution:** Before start the experiment, the user should confirm that the waste bin has been loaded.

 **Caution:** Please replace the waste bin after the experiment every time and the waste shouldn't be accumulated.

 **Biohazard:** The detecting object of Handling System is the biological samples with the potential danger of spreading and infecting disease. Please take applicable safety protection measures and wear appropriate protective goggles, clothing and gloves while processing the samples when clean up the waste.

 **Biohazard:** Please comply with the applicable local or national regulations to dispose the waste samples and contaminated materials.

6.2.5 Replace Fuse

The fuse tube (type F10AH250V) of Handling System is located in the fuse tube holder within the power interface. To ensure that keep far away from the fire danger, please replace the fuse with the instrument's right type and rated value. Before replacing the fuse tube, please switch off and unplug the instrument, and then pry the fuse box with a straight screwdriver to replace it, as shown in figure 6-1.

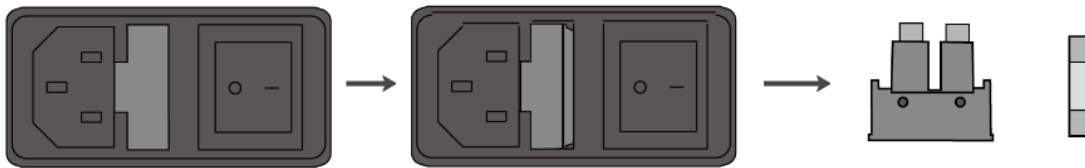

Figure 6-1. Replace Fuse Tube

⚠ Reminding: Please check the fuse tube in case there is no display on the touch screen after starting up Handling System.

⚠ Caution: improper fuse tube may lead to circuit system damage, even fire.

6.2.6 Replace UV Lamp

Two ultraviolet lamps are installed on the top of the experiment cabin. The Handling System software will prompt the user in case the UV lamp has exceeded the rated service time. User could contact **XATL Co., Ltd.** engineers to replace them.

6.2.7 Replace Filter

Handling System is equipped with an anti-contamination filter in the experiment cabin and its software will prompt user in case the anti-contamination filter exceeds the rated service time. This HEPA filter is dedicated with the specific thickness and material that is tailored by the manufacturer in the light of the related requirements. It is not allowed to replace it at will. When the HEPA filter is invalid, please contact **XATL Co., Ltd.** engineer to replace it.

6.2.8 Other Maintenance and Calibration

When the instrument is not used for a long time, please unplug it and use the soft cloth or dust bag to cover the instrument to keep the dust away.

Instrument Cleaning List

Cleaning Location		Period				Method
Item	Operation	Round	Day	Week	Month	
Material Recycle	Recycle the remaining reagent component		✓		✓	Recycle as required and please protect the bar code.
	Recycle the remaining tips		✓		✓	Recycle and store to the tip holder.
	Recycle the remaining eluent	✓			✓	Recycle and store as required. Please avoid cross contamination.
	Premixing Bottle	✓			✓	Dispose as medical and bio-waste.
	Waste Bin	✓			✓	Dispose as medical and bio-waste
	Waste Cabin	✓			✓	Please wipe the inner wall of the experiment cabin, consumable loading platform, waste bin, etc. with the soft cloth or absorbent paper sprayed by medical alcohol or 75% alcohol, but please be cautious of the possibly dropped paper scraps or soft flocks.
	Refrigeration Cabin		✓		✓	
	Eluent Area	✓			✓	
	Consumable Loading Platform	✓			✓	
	Setup/ Reservation Area	✓			✓	
	Tip Area		✓		✓	
	Experiment Operation Platform	✓			✓	
	Inner Wall of Experiment Cabin		✓		✓	
Shell				✓	✓	
Accessory Disinfection and Cleaning	Processing Liquid Holder		✓		✓	Please spray medical alcohol or 75% alcohol on reagent/ premixing bottle holder and droplet capture plate first and wipe with dry absorbent paper.
	Droplet Capture Plate	✓			✓	
	3mL DWP Connecting Plate	✓			✓	
	PCR Connecting Plate	✓			✓	
	PCR Loading Plate	✓			✓	

	PCR Reagent Trough		✓		✓	
	Reagent Connecting Holder		✓		✓	
UV Disinfection	UV Disinfection 30min	✓				Please load the reagent/ premixing bottle holders and droplet capture plate to the right position and place a new waste bin inside the waste cabin. Finally, start UV disinfection.
	UV Disinfection 60min				✓	
Touch Screen Cleaning	Touch Screen		✓			Please gently wipe the screen with a piece of dry and soft cloth.
Dirt Removing	Instrument Interior				✓	Start powerful cleaning to clean.

⚠ Reminding:

1. The daily cleaning operation in ***Instrument Cleaning List*** is provided, routinely, as 2 rounds of experiments per day. If it exceeds 3 rounds per day, the users should strengthen the cleaning depending on the actual situation.
2. After the daily operation, it is recommended to take out the processing liquid holder from instrument and place where there is ventilated and dry so as to the condensation water becomes dry.
3. The instrument should be cleaned thoroughly once a month. If the instrument is not used for one month, it is recommended to start the instrument for a dry running in order to ensure stable performance.
4. If any positive materials are spattered on the instrument during the experiment, the special cleaning treatment should be performed.

6.3 Packing, Transport and Returning to Factory Service

6.3.1 Instrument Cleaning and Disinfection

In case Handling System is moved to another lab or in need of returning to after-sale service for maintenance, the first priority is to disinfect the instrument and fill in the disinfection sheet. The disinfection process is listed as follows:

- ▶ Please wear protective devices as the lab required, such as facial mask, hat, lab-gown, goggles, disposable medical gloves, etc.;



- ▶ Please get the disinfectant (The routine disinfectant in lab) ready;
 - ▶ Please switch off the instrument and open the experiment cabin;
 - ▶ Please clean and disinfect the experiment cabin interior as section 6.1.3 required;
 - ▶ Please clean the instrument surface and touch screen with the routine detergent as section 6.1.1-6.1.2 required.
-  **Caution:** The instrument disinfection must be carried out by the trained professionals who should wear protective clothing and disposable medical gloves in a well-ventilated environment during the whole disinfection process.

6.3.2 Transport Lock Installation

If the user needs to transport Handling System again, please contact **XATL Co., Ltd.** engineer to install the transport lock in order to avoid or reduce instrument damage in the process of transportation

6.3.3 Product Package

If user needs to transport Handling System again, please properly pack the instrument and accessories with its original package in order to avoid the collision and shock for a smooth transportation process.

-  **Reminding:** Please contact our engineer to pack the product.
-  **Reminding:** The original transport package of Handling System is designed to reduce the instrument damage during transportation. To ensure the safety, please do not choose the other packaging materials and packing ways, or it may break the warranty and **XATL Co., Ltd.** won't take charge of the damage because of the improper transportation.
-  **Reminding:** The well-packed instrument could be transported by the common vehicles with awnings but the user should protect it from the violent impact, the shaking and the splashing of rain and snow.

6.4 Troubleshooting

In general, the corrective instructions will be displayed along with the error messages by Handling System software. Under normal circumstances, the software running errors can be solved by restarting the instrument or the software.

This section describes the main possible faults of Handling System together with the corresponding reasons and its solutions.

No.	Fault	Cause	Solution
1	After starts the instrument, there displays nothing on the touch screen.	The instrument isn't powered on.	Power the instrument on
		Whether the instrument switch is on or not?	Turn the switch on
		Whether the power cord plug is inserted properly or not?	Reinsert the power cord plug properly
		Whether the power socket is intact or not?	Use the suitable power socket
		Whether fuse tube is intact or not?	Replace the fuse
2	Error message or reset failure occurs at startup	A module of the instrument failed to start	Restart the instrument
		Abnormal instrument condition	Consult maintenance engineer
3	Abnormal stop while instrument running	Improper operation	Power off and restart the instrument
		Abnormal instrument condition	Power off the instrument and consult maintenance engineer
4	Failure of consumable scanning results in abnormal experiment	Scan setting error	Check the scan settings, select the correct scan options and restart the experiment
		Experiment cabin door is not well closed and affect the scan light	Properly close the experiment cabin door and re-scan
		Consumable loading error	Check the consumables and restart the experiment
5	Abnormal movement of pipetting device	Improper operation results in fault	Power off the instrument, check the consumables and restart the experiment
		Abnormal instrument condition	Power off the instrument and consult maintenance engineer
6	The subsequent PCR experiment is non-effective and unproductive	A selection error on experiment program, samples, etc.	Check the operating program and sample settings, then experiment again
		Reagent expiration, efficacy failure or quality problems	Change reagent and experiment again
		Incorrect eluent or reagent loading	Change eluent or reagent and experiment again

- ⚠ **Reminding:** Under normal situation, the faults are able to be corrected by following the corresponding methods. If not, please connect **XATL Co., Ltd.**
- ⚠ **Reminding:** Please immediately cut off the power and contact the supplier or **XATL Co., Ltd.** if the following situations occur. We will send the professional servicemen to handle the following situation:
- The liquid flows into the instrument.
 - The instrument is watered or rained.
 - Any abnormal sound or smell occurs on the instrument.
 - The instrument falls down and damages the shell.
 - The instrument function is changed obviously.
- ⚠ **Reminding:** For a patient/user/third party in the European Union and in countries with similar regulatory regime (Regulation 2017/746/EU on IVD Medical Devices); if, during the use of this device or as a result of its use, a serious incident has occurred, please report it to the manufacturer and/or its authorized representative and to your national regulatory authority.

6.5 Data Maintenance

6.5.1 Log

Runlog records the user's operations on instrument and the running process of the instrument, which is saved in form of log file to the directory C: \\ Tianlong \\PANA S401 \\ runlog.

6.5.2 Data Backup

Insert a USB drive to Handling System USB interface and find out where the **Runlog** is saved according to the path provided in section 6.5.1. Then backup the corresponding log files to the USB drive.

6.5.3 Data Recovery

Insert a USB drive to Handling System USB interface and transfer the corresponding log files to the runlog path provided in chapter 6.5.1. so as to recover Handling System log data.

7. Contact Information



Xi'an Tianlong Science and Technology Co., Ltd.

No.4266, Shanglin Road, Weiyang District, Xi'an, 710021, Shaanxi, P.R. China

Postcode:710021

Company Tel: +86-29-82682132

Company Fax: + 86-29-82216680

Email Address: inquiry@medtl.com

Website Address: www.medtl.net

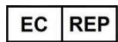

SUNGO Europe B.V.

Fascinatio Boulevard 522, Unit 1.7, 2909VA Capelle aan den IJssel, The Netherlands.

Tel: +31(0)10 3034500; +31(0)2021 11106

Email Address: ec.rep@sungogroup.com



Annex I. Quick Guide of Experiment Operation

A. Experiment Preparation

1. Reagent Preparation

- ▶ Please take out the reagent from the refrigerator, thaw it to room temperature and thoroughly mix for use.



2. Instrument Preparation

- ▶ Please power on Handling System.
- ▶ Please login Handling System and it will automatically complete the self-inspection.
- ▶ Please select experiment items in  **Items** column and input sample quantity in  **Samples** column on the experiment preparation interface.

3. Reagent and Consumable Preparation

- ▶ Please load 50 μ L and 1000 μ L Tip to meet the experiment dosage;
- ▶ Please place 8-strip PCR tube or 96-well PCR plate in the setup/reservation area;
- ▶ Please place reagent/premix bottles to their corresponding holder;
- ▶ Please place the DWP with nucleic acid extraction eluent to eluent area;
- ▶ Please be sure that there is empty waste bin in waste cabin.

B. Experiment Running

- ▶ Please click <  **Start** > on the Handling System software to start running the experiment.
- ▶ Please click <  **Pause** > or <  **Stop** > to pause or stop the currently running experiment.

C. Experiment Completed

1. Product Transfer

- ▶ After the experiment, please cap PCR consumables and transfer PCR reaction system established by the Handling System to PCR equipment for follow-up experiment.
- ▶ After the experiment, please cap the reservation consumables and transfer the nucleic acid extraction eluent to the -20°C refrigerator.

2. Reagent Recycle

- ▶ After the experiment, please cap the remaining reagent bottles in the reagent and premixing area and store them into a -20°C refrigerator.

3. Instrument Cleaning and Maintenance

- ▶ After the experiment, please regard the used consumables such as DWP, tips, reagent /premixing bottles, etc. as biological contaminants and comply with all applicable local or national regulations for disposal.
- ▶ Please regard the waste bin and the waste in it as biological contaminants to dispose and change a new waste bin.
- ▶ Please click < **Decontamination** > under the **Maintenance** tab in the System Settings interface and click < **Start** > to disinfect the experiment cabin.
- ▶ Shutdown the Handling System after the UV disinfection.

 **Reminding:** Please do not open the experiment cabin door during the UV disinfection.

Annex II. Accessories List and Usage

A. Accessories List

No.	Accessories	Qty.	Replacement Period	Replace Method	Specification & Model	Remark
1	Power Cord	1	/	/	3×0.75mm ² , 1.5m	EU
					3×18AWG, 1.5m	USA, Canada
					3×0.75mm ² , 1.5m	Korea
					3×0.75mm ² , 1.5m	China
2	Waste Bin	1	/	/	/	Dedicated
3	Fuse	2	Replace after broken	See user manual in section 6.2.5	F10AH250V	
4	Droplet Capture Plate	1	/	/	/	
5	Cap Holder of Reagent Bottle	2	/	/	/	
6	Support Plate of Reagent/Premixing Bottle Holder	1	/	/	/	
7	Reagent/Premixing Bottle Holder	3	/	/	/	Dedicated
8	PCR Loading Plate	8	/	/	/	Dedicated
9	PCR Reagent Trough	5	/	/	/	Dedicated
10	Connecting Holder for Reagent Trough	1	/	/	/	Dedicated
11	PCR Connecting Plate	6	/	/	/	Dedicated
12	User Manual	1	/	/	Attached Document	
13	Certification	1	/	/	Attached Document	
14	Packing List	1	/	/	Attached Document	
15	Zipper Bag	1	/	/	A4 Document Pouch	Paper document with the instrument
16	Handling System Transportation Support	1	/	/	/	Alternative

B. Handling System Transportation Support

Transportation Support Parameter

Support Dimension: 863 mm × 684 mm × 709mm

Support Weight: 38kg

Support External View: Refer to Annex-figure 2-1.

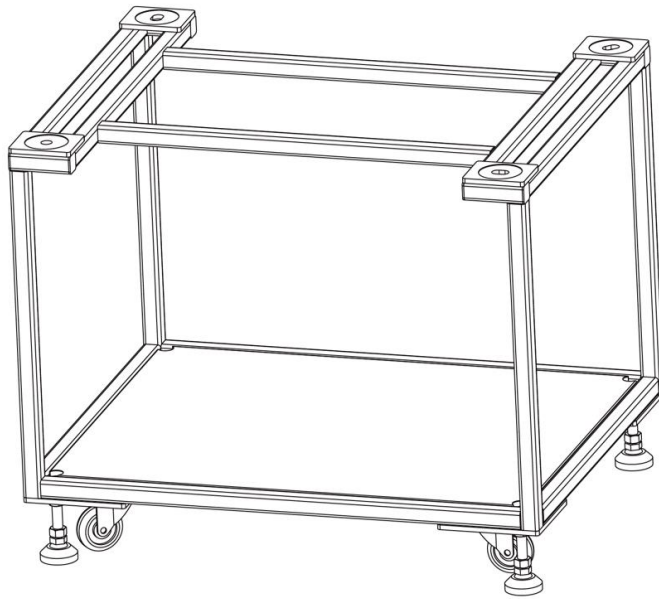

Annex-figure 2-1. Handling System Transportation Support

⚠ Reminding: Handling System transportation support is intended for supporting and carrying the instrument. User could select it if needs.

Annex III. Wooden Case Unpacking Instructions

Unpacking Instructions

Handling System is transported via wooden case which is made up of roof plate, side plate and bottom support plate, as shown in Annex-figure 3-1. The Handling System is tightly and evenly wrapped with PE stretch film and fixed inside the wooden case to prevent the collisions and shocks during transport.

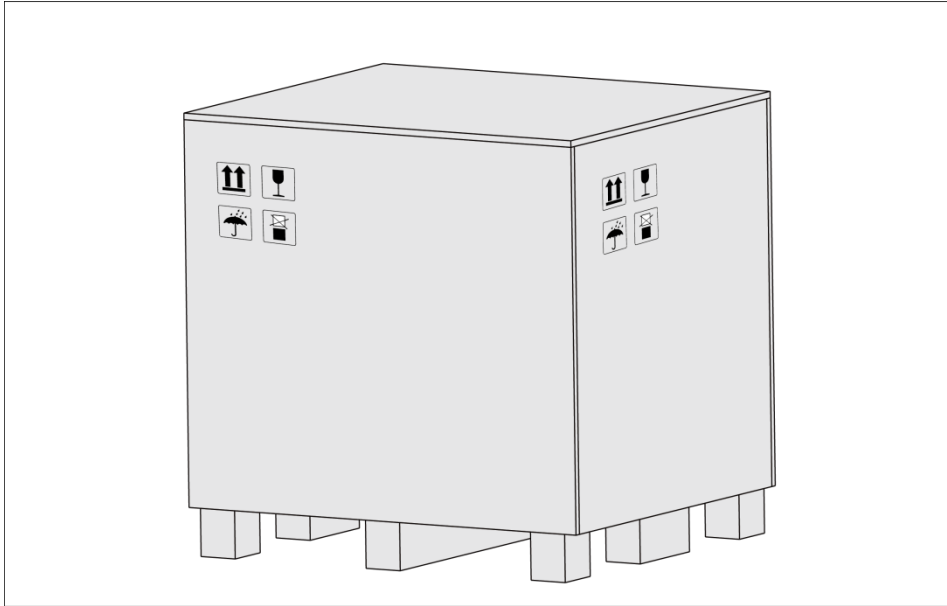

Annex-figure 3-1. Wooden Case External View

The unpacking of wooden case mainly includes 5 steps. The specific operation method is as follow.

1st Step: Please remove roof plate first, as shown in Annex-figure 3-2a.

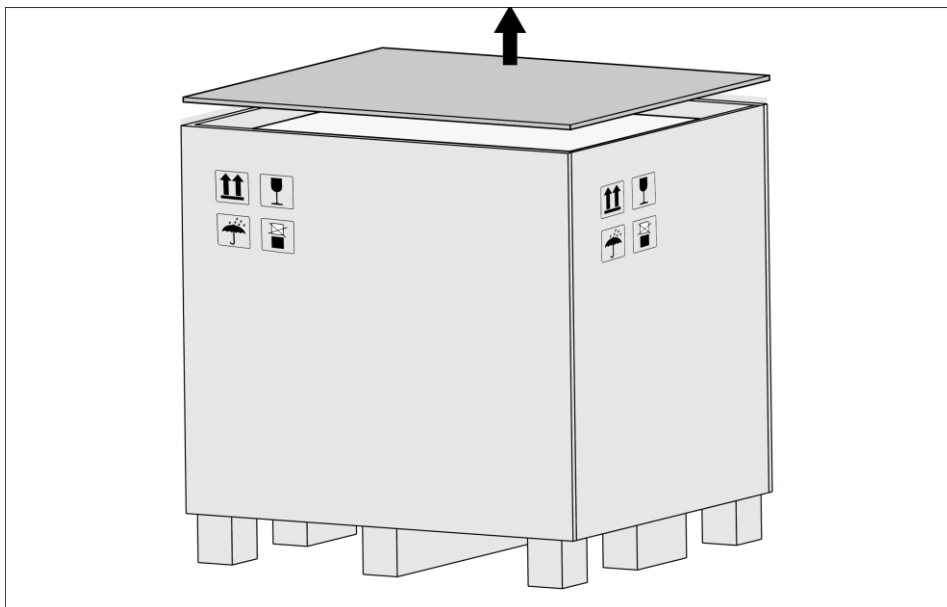

Annex-figure 3-2a. Remove Wooden Case Roof Plate

2nd Step: Then, please disassemble the side plates, as shown in Annex-figure 3-2b.

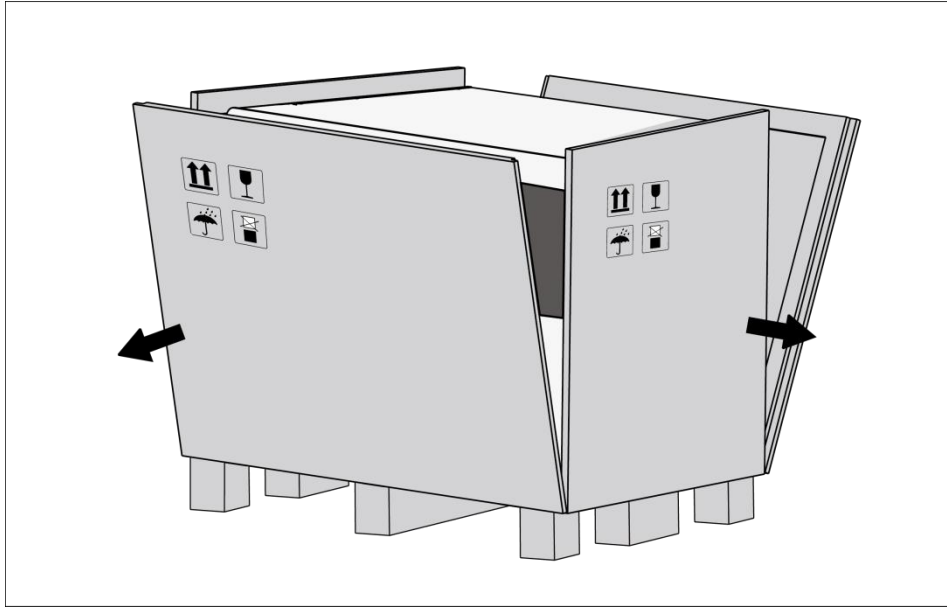

Annex-figure 3-2b. Remove Wooden Case Side Plate

3rd Step: Handling System stands on the bottom plate with its four feet which is matched with a fixed plate, fixed by the M8 bolt and nut, for each of them screwed up on the bottom plate. Please unscrew the four fixed screws and remove the bottom plate, as shown in Annex-figure 3-2c.

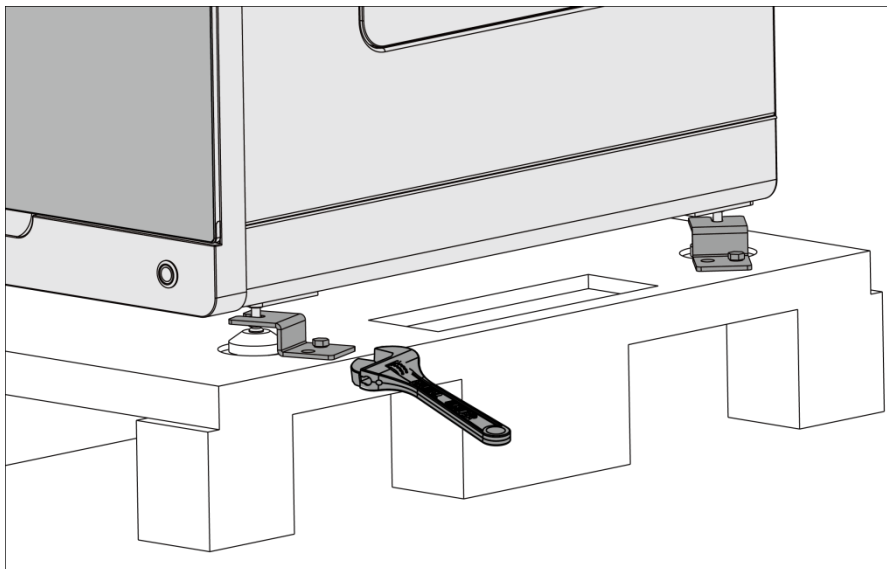

Annex-figure 3-2c. Unscrew

4th Step: There is the slot for installing the handle besides each foot. Please install the four transport handles in each slot, as shown in Annex-figure 3-2d. With persons'

cooperation, please together lift the instrument out of the package with hands holding the handles and the instrument body and carry it to the installing location.

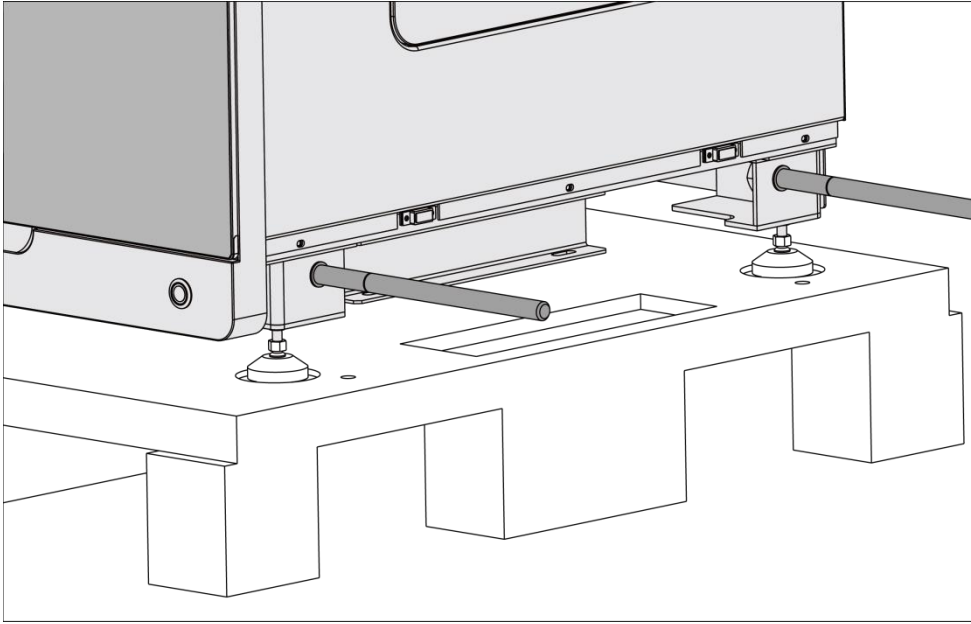

Annex-figure 3-2d. Transport Handles Application

5th Step: Please place Handling System on a steady platform, rotate down the supporting feet to land. Adjust supporting feet to the same level to ensure Handling System stands steadily before install the magnetic plate on instrument's two sides, as shown in Annex-figure 3-2e.

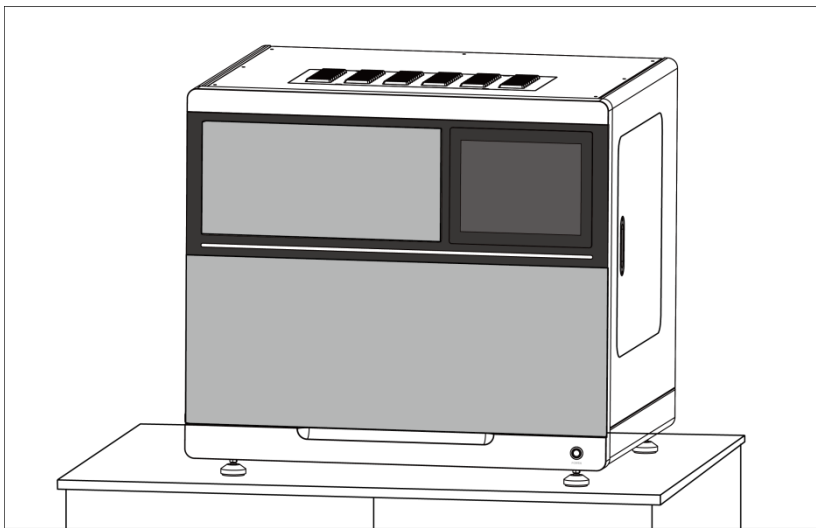

Annex-figure 3-2e. Adjust Supporting Feet Height and Install Magnetic Plate

- ❗ **Reminding:** In order to prevent the formation of condensation water, please do not open the package until it reaches room temperature.
- ❗ **Reminding:** Please carefully check the package integrity and the anti-collapse card outside the package before open it. If you are confronted with these following situations, please do not unbox and contact the transport department or **XATL Co., Ltd.** to solve the problems.
 - The anti-collapse card shows the case was ever collapsed during transportation;
 - The case material is abnormal or has been opened;
 - There is collision trace on the case or the damage and deformation occurs;
 - The water stain or waterlogging lies on case.
- ❗ **Reminding:** The attached files are all placed in the case while the instrument accessories are transported independently. Please refer to the packing list for details. Please check and receive the product and accessories according to the packing list after unboxes. If something is missed, please contact **XATL Co., Ltd.** or the agency to supplement immediately.
- ❗ **Reminding:** Please fill in the relevant content on installation information feedback table after product acceptance and send it back to **XATL Co., Ltd.** for filing and warranty.
- ❗ **Reminding:** If there's no special situation, the product should be unboxed and installed by the professionals.
- ⚠ **Caution:** The transport package of Handling System is designed to reduce the instrument damage and ensure its safety. Adopt other packaging materials will break the warranty and **XATL Co., Ltd.** will not be responsible for damages as consequences of improper packaging that incurred during the transportation. Please also keep the instrument related documents provided by **XATL Co., Ltd.** for future use too.

Annex IV. Carton Box Unpacking Instructions

Unpacking Instructions

Handling System is transported via carton box which is made up of outer layer that is carton and inner layer that is foam supporting plate, as shown in Annex-figure 4-1. The Handling System is tightly and evenly wrapped with PE stretch film and fixed on the wooden supporting base to prevent the collisions and shocks during transport.

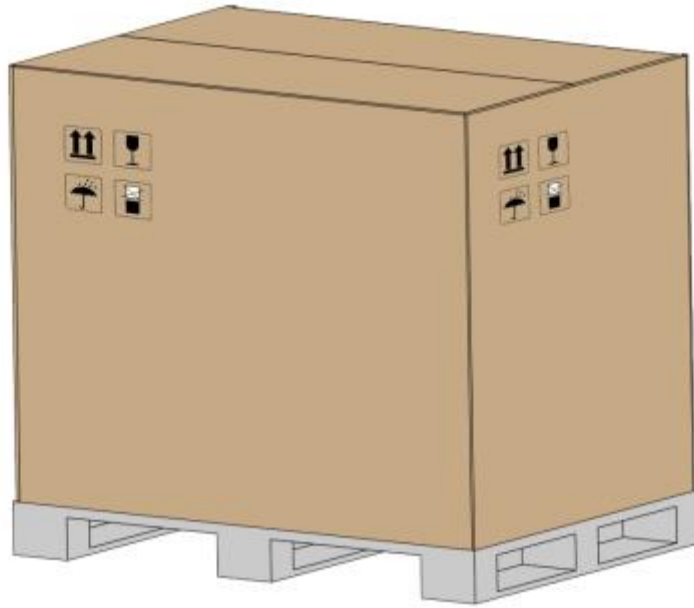

Annex-figure 4-1. Carton Box External View

The unpacking of carton box mainly includes 4 steps. The specific operation method is as followed.

1st Step: Cut the strapping tape around the carton box, remove it upwards, take out of all the accessories from the top foam and remove it together with bottom foam, as shown in Annex-figure 4-2a and Annex-figure 4-2b.

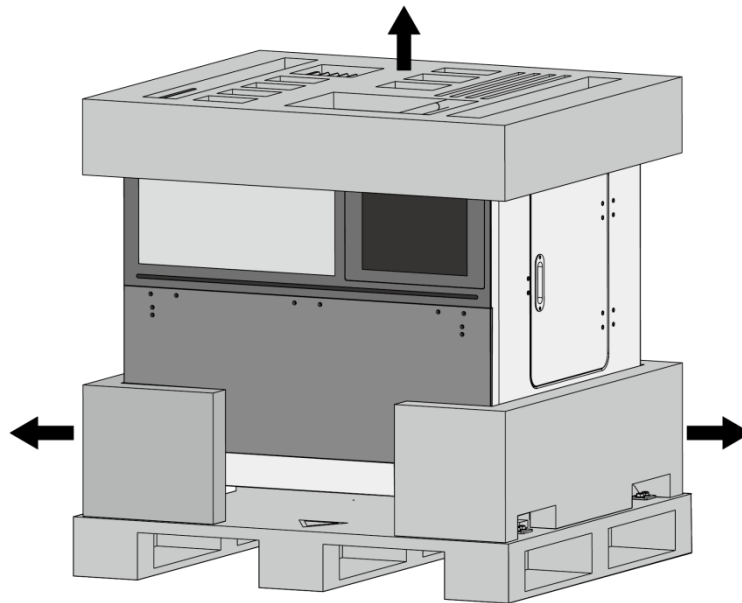

Annex-figure 4-2a. Remove Carton Box

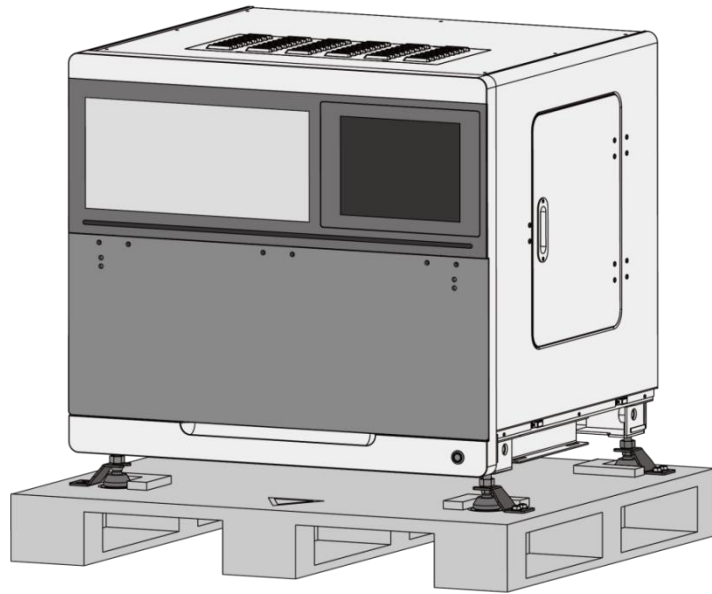

Annex-figure 4-2b. Handling System Instrument

2nd Step: Handling System stands on the wooden supporting base with its four feet which is matched with a fixed plate fixed by the M8 bolt and nut, for each of them screwed up on the supporting base. Please unscrew the four fixed screws and remove the fixed plate, as shown in Annex-figure 4-2c.

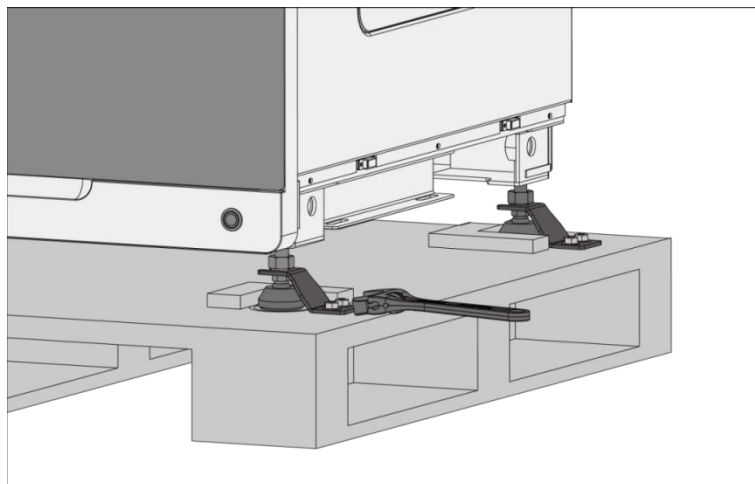

Annex-figure 4-2c. Unscrew the Fixed Plate

3rd Step: There is the slot for installing the handle besides each foot. Please install the four transport handles in each slot, as shown in Annex-figure 4-2d. With persons' cooperation, please together lift the instrument out of the package with hands holding

the handles and the instrument body and carry it to the installing location.

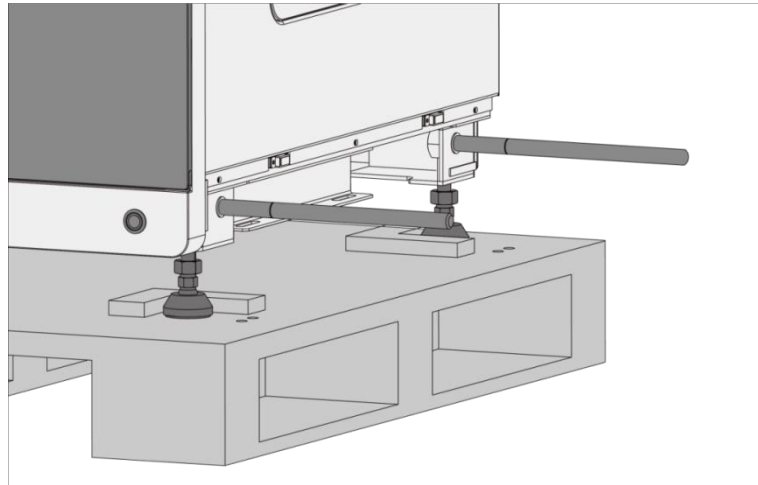



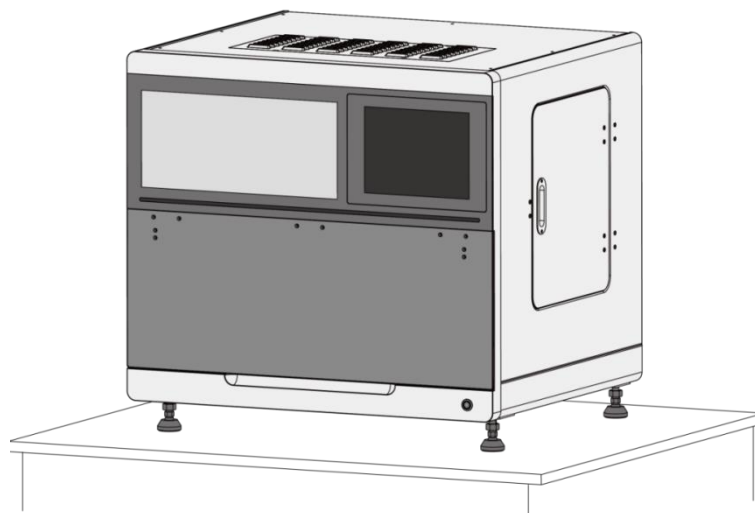

Annex-figure 4-2d. Transport Handles Application

4th Step: Please place Handling System on a steady platform, rotate down the supporting feet to land. Adjust supporting feet to the same level to ensure Handling System stands steadily before install the magnetic plate on instrument's two sides, as shown in Annex-figure 4-2e.



Annex-figure 4-2e. Adjust Supporting Feet Height and Install Magnetic Plate

- ❗ **Reminding:** In order to prevent the formation of condensation water, please do not open the package until it reaches room temperature.
- ❗ **Reminding:** Please carefully check the package integrity and the anti-collapse card outside the package before open it. If you are confronted with these following situations, please do not unbox and contact the transport department or **XATL Co., Ltd.** to solve the problems.

- The anti-collapse card shows the case was ever collapsed during transportation;
 - The case material is abnormal or has been opened;
 - There is collision trace on the case or the damage and deformation occurs;
 - The water stain or waterlogging lies on case.
-  **Reminding:** The attached files are all placed in the case while the instrument accessories are transported independently. Please refer to the packing list for details. Please check and receive the product and accessories according to the packing list after unboxes. If something is missed, please contact **XATL Co., Ltd.** or the agency to supplement immediately.
-  **Reminding:** Please fill in the relevant content on installation information feedback table after product acceptance and send it back to **XATL Co., Ltd.** for filing and warranty.
-  **Reminding:** If there's no special situation, the product should be unboxed and installed by the professionals.
-  **Caution:** The transport package of Handling System is designed to reduce the instrument damage and ensure its safety. Adopt other packaging materials will break the warranty and **XATL Co., Ltd.** will not be responsible for damages as consequences of improper packaging that incurred during the transportation. Please also keep the instrument related documents provided by **XATL Co., Ltd.** for future use too.



TIANLONG

Xi'an Tianlong Science and Technology Co.,Ltd.

Add: No.4266, Shanglin Road, Weiyang District, Xi'an, 710021, Shaanxi, P.R. China

Tel: +86-29-8268 2132

Fax: +86-29-8221 6680

<https://www.medtl.net>
