

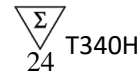

Viral DNA and RNA Extraction Kit (Panall 8000 MD System, Pre-filled)

User Guide

Version 2.0



In-Vitro Diagnostics / For use with Automatic nucleic acid extractor compatible with
Viral DNA and RNA Extraction Kit



T340H



Xi'an Tianlong Science and Technology Co., Ltd.

No.389, Zhuhong Road, Xi'an, 710018, Shaanxi, P.R. China;
2-3F, No. 2 Building, Yuanzheng Innovation Park, Caotan Ecological Zone, No.1258, Hongye Road,
Economic & Technological Development Zone, Xi'an, 710018, Shaanxi, P.R. China.



SUNGO Europe B.V.

Olympisch Stadion 24, 1076DE Amsterdam, Netherlands.

Contents

Intended Use.....	1
Product Performance Indicators.....	1
Special Notes.....	1
Testing Principle.....	1
Kit Contents.....	2
Materials Required but not Provided	2
Warnings and Precautions	2
Reagent Storage and Handling.....	3
Sample Handling and Storage	4
Operation Guide.....	4
1. Automated Extraction Process.....	4
2. Operation Steps of Automated Extraction.....	4
2.1 Start Up	4
2.2 Sample and Consumable Loading	5
2.3 Procedure Run.....	8
2.4 Cleaning and Maintenance of the Instrument.....	10
Troubleshooting Guide	10
Quality Control.....	10
Limitations of Test Methods	10
Safety Symbols and Signs.....	11
Contact Information.....	11

Kit Version	2.0		
Changes	Relevant descriptions in the intended use	Additions	/

Intended Use

Viral DNA and RNA Extraction Kit (Panall 8000 MD System, pre-filled) is designed to rapidly extract viral DNA and RNA from swab wash buffer. The extracted viral DNA and RNA are of high purity and stability, and can be used in a variety of routine operations, including enzyme digestion, Polymerase Chain Reaction (PCR), DNA library constructions, Southern hybridization and blotting and other experiments.

Viral DNA and RNA Extraction Kit (Panall 8000 MD System, pre-filled) is intended to be used by professional users, such as biotechnologists, microbiologists, clinical technicians and physicians who are trained in molecular biological techniques.

Product Performance Indicators

The extraction kit can extract more than 100 copies/mL viral DNA nucleic acid, and more than 100 copies/mL viral RNA nucleic acid. Both the intra and inter-batch variations of the kit are less than 5%.

Special Notes

Viral DNA and RNA Extraction Kit (Panall 8000 MD System, pre-filled) is worked with TIANLONG® Panall 8000 All-in-one Molecular Diagnosis System (Panall 8000 MD System) that has been disinfected by UV light before use. After an experiment, wipe the inside of the extractor with 75% ethanol and disinfect with UV light for 15 mins. The Panall 8000 All-in-one Molecular Diagnosis System automates the entire purification process that can process 1-8 samples in a single run.

The kit is used to extract viral DNA and RNA targets. To avoid RNA degradation by RNase during operations, use exclusive-use utensils, sample injectors, disposable centrifuge tubes and tips processed by autoclave before using. The operator should wear powder-free gloves, a mask and protective coverall.

The kit has magnetic beads with a unique separation function and a unique buffer system to extract, isolate and purify high-quality nucleic acids from a variety of liquid samples such as swab wash buffers.

Magnetic beads enable the purification of high-quality nucleic acids that are free of protein, nuclease, and other impurities. Purified nucleic acids can be widely used in a variety of routine operations, including downstream experiments such as enzyme digestion, Polymerase Chain Reaction (PCR), DNA library construction, Southern hybridization and blotting.

Please carefully read the manual of instructions before attempting to install or use the product for the first time. To consider all possible consequences of misoperations or non-recommended functions, pay special attention to possible consequences.

Testing Principle

Viral DNA and RNA Extraction Kit (Panall 8000 MD System, pre-filled) is worked with TIANLONG® Panall 8000 All-in-one Molecular Diagnosis System (Panall 8000 MD System) designed by Xi'an Tianlong Science and Technology Co., Ltd. Magnetic beads are adsorbed, transferred and released using special magnetic rods based on the principle of magnetic bead adsorption. The extraction process enables the conduction of nucleic acid extraction and final adsorption of highly pure nucleic acids with the transfer of magnetic beads and nucleic acids.

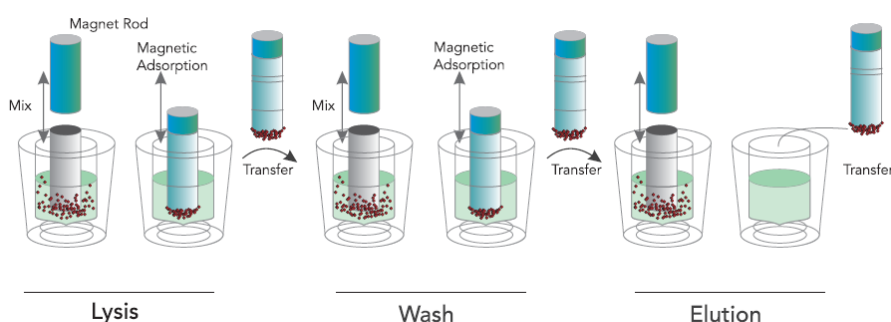

Figure 1. Schematic Diagram of Panall 8000 MD System

An Panall 8000 All-in-one Molecular Diagnosis System (Panall 8000 MD System) performs the following steps on a sample containing magnetic particles:

A magnetic rod protected by the mixing sleeve insert into a well which contains sample. The mixing sleeve stirs rapidly and repeatedly in the liquid to ensure complete mixing of the liquid and magnetic beads. After cell lysis, nucleic acid adsorption, washing and elution, high-purity nucleic acid is obtained.

Panall 8000 MD System equipped with a magnetic head that contains an array of 8 magnetic rods, allowing it to process up to 8 samples simultaneously.

Kit Contents

Short Code		T340H
Name of Component		
Pre-filled	Size	24T/Box
	Component	Pre-filled 10 strip tube
Reagent	Quantity	24
	Component Specification	1 Test
Instructions for Use		1 Copy

Materials Required but not Provided

When working in a laboratory, make sure to wear a proper lab coat, powder-free disposable gloves and protective goggles. For more information, please consult the Safety Data Sheet (SDS) available from the product supplier.

- 75% ethanol

Warnings and Precautions

Please be sure to read the precautions before using the kit.

The kit is used to extract viral DNA and RNA targets. To avoid RNA degradation by RNase during operation, use exclusive-use utensils and sample injectors, and use disposable centrifuge tubes and tips processed by autoclave before using. The operator (researcher or clinical expert) should wear powder-free gloves and a mask and protective coverall.

Please read the manual carefully before using the kit, and strictly follow the manual throughout operation. The subjected clinical samples should be collected on a clean bench or in a biosafety cabin.

Before using TIANLONG® Panall 8000 All-in-one Molecular Diagnosis System (Panall 8000 MD System), it must be disinfected by UV light. After experiment, wipe the inside of the extractor with 75% ethanol and disinfect it with UV light for 15 mins.

Do not mix reagents from different batches, use the kit within the expiry date.

Dispose of all samples and reagent materials used in experiment, and clean and disinfect the experimental work bench thoroughly.

The **Viral DNA and RNA Extraction Kit (Panall 8000 MD System, pre-filled)** is intended for in vitro diagnosis use.

When using kit, always wear a suitable lab coat, disposable gloves, and protective goggles. For more information, please consult the appropriate Material Safety Data Sheets (MSDSs). These documents are available online in a convenient and compact PDF format at <https://www.ug-msds.com/MSDS1>, where the operator can find, view and print the appropriate MSDSs.

⚠ Caution: Do not add any bleach or acidic solution directly to the pre-filled reagent.

The pre-filled reagent contains guanidinium salts, which, when combined with bleach can form highly reactive compounds. If any of buffers are spilled, clean immediately with a suitable laboratory detergent and water. If the spilled liquid contains potentially infectious agents, clean the affected area with

laboratory detergent and water first. And clean with sodium hypochlorite at a concentration of 1% (v/v). Be aware of following warnings and precautions while using *the Viral DNA and RNA Extraction Kit (Panall 8000 MD System, pre-filled)*.

● **Product contents**

Guanidine hydrochloride, sodium dodecyl sulfate, trihydroxymethyl aminomethane, isopropanol, absolute ethanol.

● **Toxicological information**

Skin corrosion/irritation

May irritate the skin.

Severe eye damage/eye irritation

May cause irreversible eye damage.

Respiratory or dermal sensitivity

No relevant data is available.

Germ cell mutagenesis

Do not conform with the classification criteria based on the existing data.

Carcinogenicity

Do not conform with the classification criteria based on the existing data.

Reproductive toxicity

Do not conform with the classification criteria based on the existing data.

Specific target organ toxicity - single exposure

May cause drowsiness or dizziness.

Specific target organ toxicity - repeated exposure

Do not conform with the classification criteria based on the existing data.

Potential health effects

Inhalation: Avoid inhalation of concentrated vapour. Inhaling a large amount of vapour may cause respiratory irritation. May cause drowsiness or dizziness.

Skin contact: May cause skin irritation.

Eye contact: Liquid contact may cause eye damage.

Ingestion: For any unexpected route of exposure, it may be harmful if ingested.

● **Ecological Information**

Ecotoxicity: Harmful to aquatic life with long-lasting effects.

Mobility: No relevant data is available.

Bioaccumulation potential: No relevant data is available.

Environmentally adverse effects: No relevant data is available.

Other adverse effects: Do not allow the product to enter drains or water sources.

● **First aid measures**

In case of eye contact: Immediately rinse the upper and lower eyelids with plenty of water.

In case of skin contact: Immediately remove contaminated clothing thoroughly, rinse the skin with soap and plenty of water. If irritation persists, immediately contact nearest doctor/physician.

In case of inhalation: Keep away from exposure and transfer to a place with fresh air.

In case of ingestion: Do not give anything orally to an unconscious person. Rinse mouth thoroughly with water and seek immediate medical attention for symptomatic treatment.



Reagent Storage and Handling

The Viral DNA and RNA Extraction Kit (Panall 8000 MD System, pre-filled) should be stored at room temperature in a cool, dry and well-ventilated area. All components of the kit can be adequately store for up to 12 months.

The kit should be used in a well-ventilated area, and keep away from the source of heat, sparks, open flames and smoking.

To avoid evaporation, the pre-filled reagent should be used immediately after open, and not be placed open for a long period of time.

Avoid exposure of the kit to UV light (e.g., for decontamination), which may result in accelerated aging.

Sample Handling and Storage

Prevent foam formation inside or on the samples. Depending on the starting material, sample pre-treatment may be required. Samples should be stored at room temperature (15~25°C) before starting the experiment.

Samples should be used immediately after collection to extract nucleic acid or stored at 2~8°C for further experiment within 24 hours. While for long-term storage, the samples should be placed at -20°C.

Operation Guide

1. Automated Extraction Process

Panall 8000 All-in-one Molecular Diagnosis System(Panall 8000 MD System) enables nucleic acid extraction by magnetic beads. It uses magnetic rods to move the beads adsorbed with nucleic acid into different reagent well. Magnetic rod protected by the mixing sleeve which stirs rapidly and repeatedly in the liquid to ensure complete mixing of the liquid and magnetic beads. After cell lysis, nucleic acid adsorption, washing and elution, the high-purity nucleic acid is obtained. Panall 8000 All-in-one Molecular Diagnosis System (Panall 8000 MD System) are characterized by high automation, rapid extraction speed, stable results, and ease of operation. The system is compatible with special reaction consumables and can process up to 1~8 samples concurrently.

The Panall 8000 All-in-one Molecular Diagnosis System(Panall 8000 MD System) can extract and purify nucleic acids from human samples using a variety of magnetic bead-based nucleic acid extraction reagents. Automatic nucleic acid extractors have a wide range of applications in scientific research, clinical practice, disease control, food safety, forensics and other fields. The user needs to put sample tubes and the pre-packaged nucleic acid extraction into the instrument, full-automatic nucleic acid extractors then perform all nucleic acid extraction operations according to the experimental procedures.

The Panall 8000 All-in-one Molecular Diagnosis System (Panall 8000 MD System) is shown in Figure 2. Please refer to the user manual provided with an instrument for operating instructions.



Figure 2. Panall 8000 MD System

2. Operation Steps of Automated Extraction

2.1 Start Up

Turn on the power switch on the backside of All-in-one System. After 10 seconds, turn on the instrument switch on the instrument panel and the instrument starts to run with a short bleep.

After starting All-in-one System, the user could double click <  > on the desktop of the instrument touch screen to run the application software. All-in-one System will inspect and initialize the instrument automatically.

After the system self-inspection, the master screen automatically shows the login interface, as shown in figure 3. The user could enter the account in the <Username> box and the password in the <Password> box and click <Login> to login.

After login, the system will enter the main interface (shown in Figure 4).

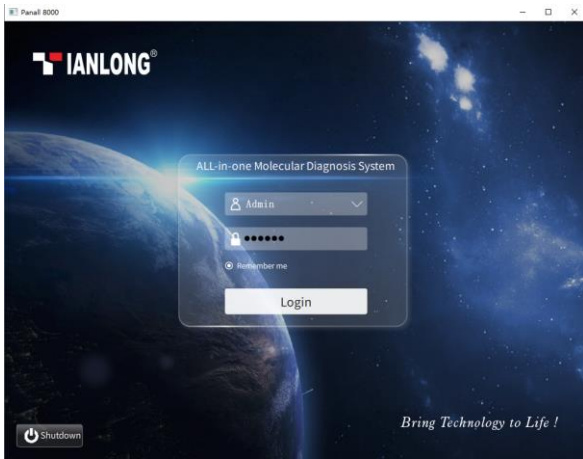

Figure 3. All-in-one System—Login Interface

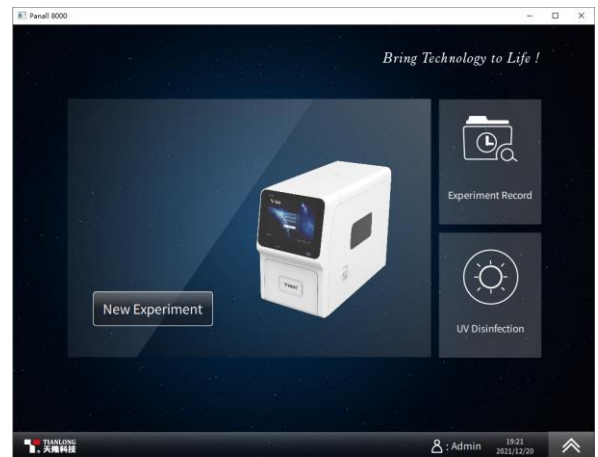

Figure 4. All-in-one System - Main Interface

2.2 Sample and Consumable Loading

Click <New Experiment> in the main interface and the system will enter experiment preparation interface, which is shown in figure 5. Please select the pre-packaged nucleic acid extraction and PCR reaction reagents matched with the experiment type. Samples and Consumable are loaded correctly according to 2.2.1, 2.2.2 and 2.2.3.

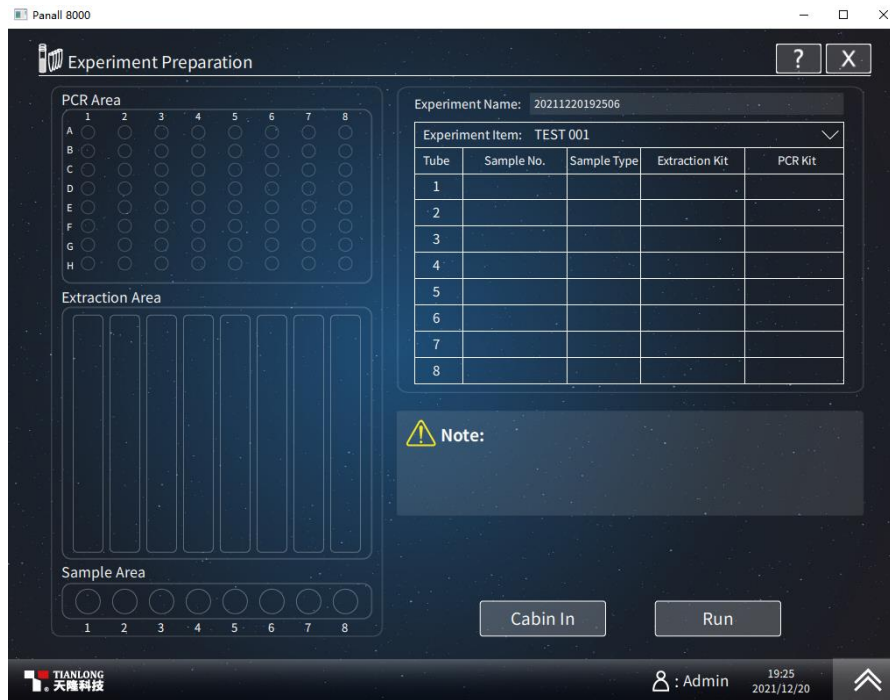

Figure 5. Experiment Preparation Interface

2.2.1 Sample Loading

Hold the sample tube with the barcode facing the scanning port for sample identification and the sample information is recorded into the software (shown in figure 6).

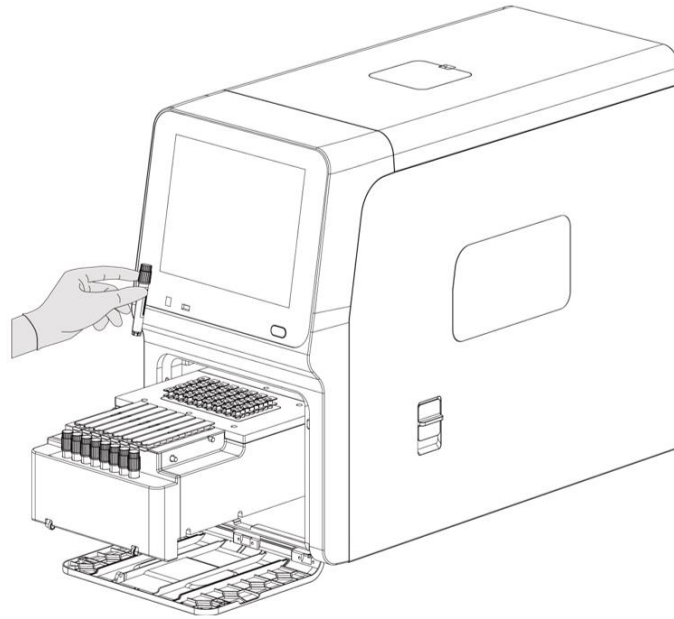

Figure 6. Sample Tube Barcode Scan

The loading area is with maximum capacity of 8 sample tubes. The user inserts the sample tube into the well after scanning (shown in figure7).

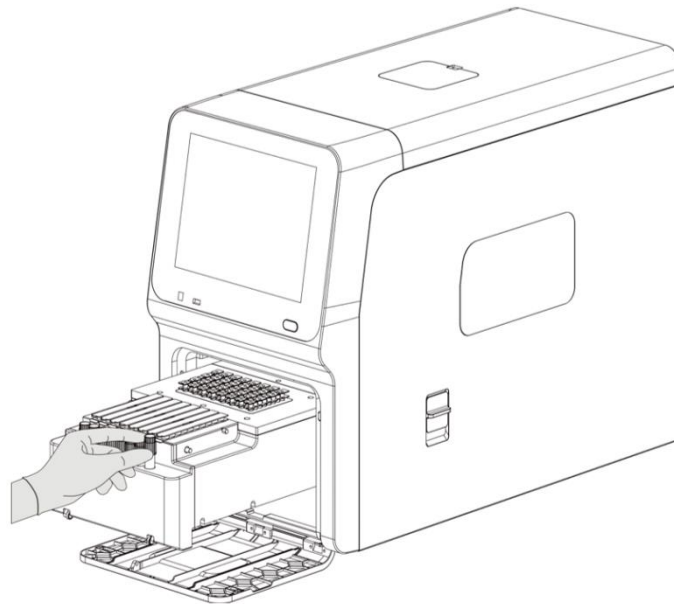

Figure 7. Sample Tube Loading

⚠ Note: The green light turns on after loading the sample tube into the well. If the green light is not on, please confirm whether the sample tube is loaded properly. Insert sample tube into the well till the green light is on. Otherwise, it may indicate sample loading failed or instrument damaged.

⚠ Caution: Please ensure that the maximum sample volume doesn't exceed two thirds of the tube volume, it may cause the sample spill out leading to contaminating and damaging the instrument during loading the sample.

2.2.2 Load Nucleic Acid Extraction Consumables

The loading area is with maximum capacity of 8 sample tubes. Load the nucleic acid extraction consumables, to the same column of the extraction area on the sample tube loading position. The rod cover side of the nucleic acid extraction needs to be placed close to PCR reaction area (shown in figure 8).

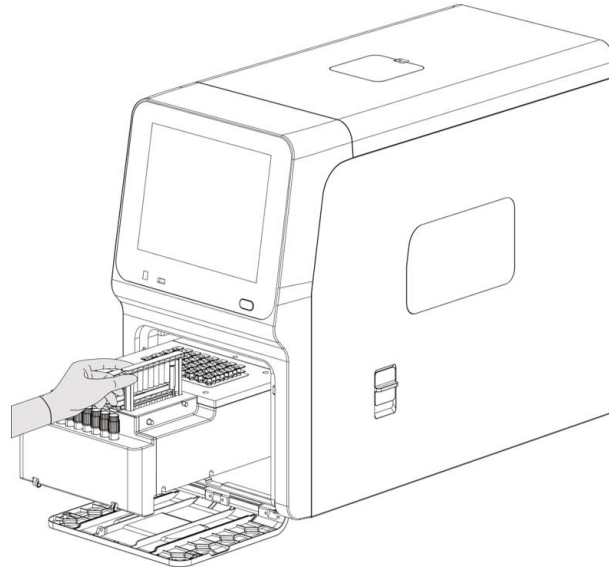

Figure 8. Nucleic Acid Extraction Consumables Loading

- ⚠ Note: Before loading nucleic acid extraction consumables, its outer package should be removed. Please slightly swing or centrifuge the consumables to ensure the pre-aliquot reagent centers at the bottom to avoid lots of magnetic beads or reagents in the sidewall or seal.
- ⚠ Note: Please carefully check the extraction reagent type before loading and ensure the barcode on the consumable is complete and clear for instrument of being able to read the reagent information.
- ⚠ Note: The consumable loading well in nucleic acid extraction area is designed as anti-misalignment. If the user does not load the consumable in the right direction, the consumable could not be placed into the well.

2.2.3 Load PCR Reaction Consumable

The loading area is with a maximum capacity of 8 sample tubes. Load the PCR reaction consumables to the same column of the PCR reaction area following the loading position of the sample tube and the nucleic acid extraction consumables. The special tube side of PCR reaction consumables need to be placed close to the nucleic acid extraction area (shown in Figure 9).

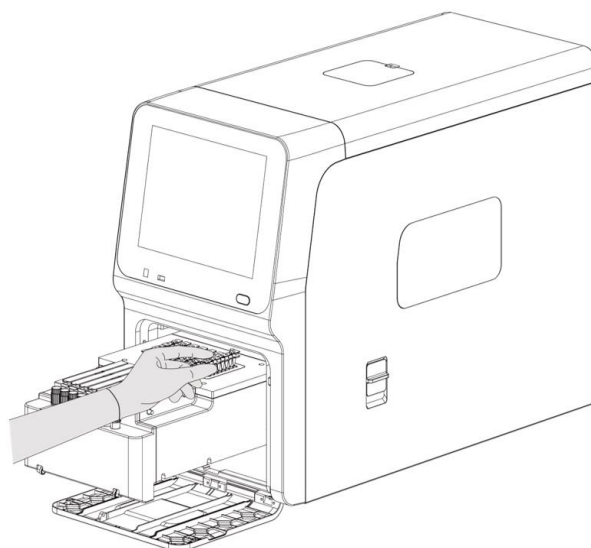

Figure 9. PCR Reaction Consumables Loading

⚠ Note: The consumable loading well in PCR reaction area is designed as anti-misalignment. If the user does not load the consumable in the right direction, the consumable could not be placed into the well.

⚠ Note: Please carefully check the PCR reaction reagents type before loading and ensure the barcode on the consumable is completed and clear so that the instrument can read the PCR reaction reagent information.

2.3 Procedure Run

The user can set related experiment information of experiment name, experiment item, sample type, etc. The information of sample number, extraction reagent and amplification reagent is automatically displayed after scanning the barcode (shown in figure10).

Click <Experiment Name> box to enter an experiment name with character length edited as 1-32.

Click <Experiment Name> and select the experiment item to set from the dropdown list where shows all the experiment items loaded in the instrument.

The user could select any sample and click <Sample Type> to select the type as to-be-tested, positive and negative from the dropdown list.



Tube	Sample No.	Sample Type	Extraction Kit	PCR Kit
1				
2				
3				
4				
5				
6				
7				
8				

Figure 10. Experiment Information Edit Area

The instrument automatically scans the consumable information after the user clicks <Run>. If nothing is abnormal, it will automatically enter the experiment monitoring interface from the experiment preparation interface (shown in figure 11).



Figure 11. Experiment Monitoring Interface

The experiment monitoring interface displays the current experiment name and the experiment progress area displays the current experiment steps, including sample loading, nucleic acid extraction, pipetting and PCR reaction. The different colors of the light circle represent the different steps. The yellow blinking

cursor means the experiment in this area is proceeding and the time in the middle means the remaining time of the experiment step.

Click <Stop> and Click <OK> to stop the experiment (shown in figure 12).

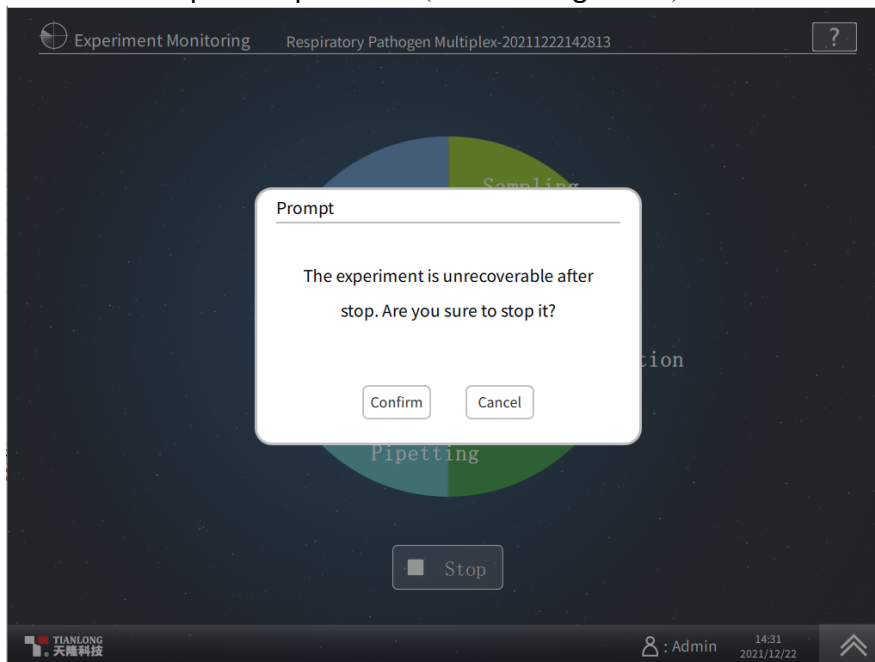

Figure 12. Stop Experiment

Click <Details> to check the detailed experiment running progress during the experiment running (shown in Figure 13).

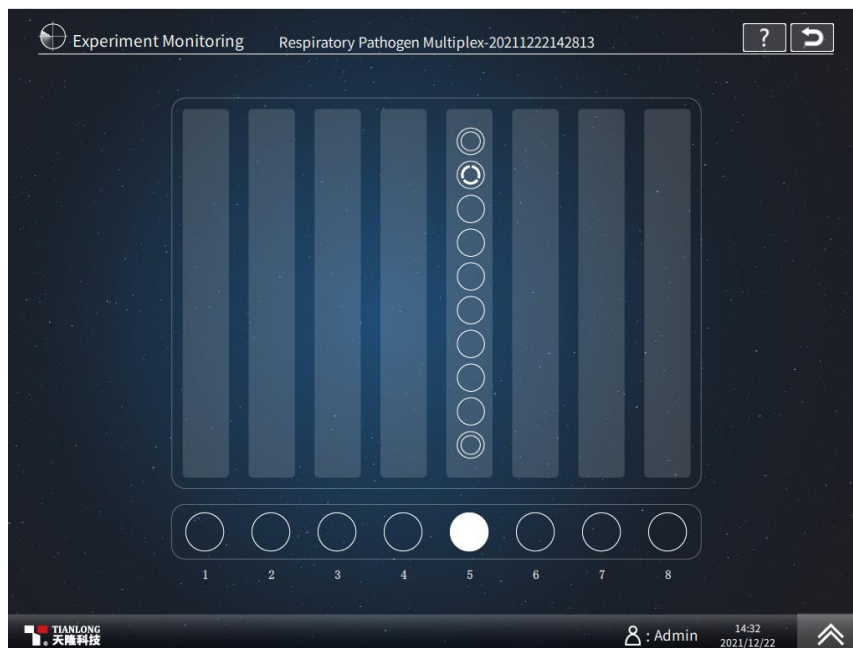



Figure 13. Details

! Note: The user can click <  > on the top right corner of the experiment preparation interface to close this interface and can click <  > on the top right corner to view the user manual.

After an experiment run, the instrument will notify the user that the experiment is completed.

! **Caution:** Any used Pre-filled 10 Tubes and mixing sleeve should be considered as biological contaminants and disposed of in accordance with relevant regulations.

! **Caution:** Using expired reagents or those that are not compatible with this instrument does not guarantee that the expected results will be obtained.

2.4 Cleaning and Maintenance of the Instrument

Follow the Cleaning and Maintenance of Instrument in accordance with the user manual provided with the equipment. Ensure that the experimental chamber is cleaned regularly to minimize the risk of cross-contamination.

Troubleshooting Guide

This troubleshooting guide should assist you in resolving any problems that arise during the experimental process. For more information and Frequently Asked Questions, please visit our Technical Support Centre at <http://www.medtl.net>. The scientists in Tianlong's Technical Services Department are always available to assist with any questions you may have about the information, protocols contained in the manual, as well as sample and assay technologies (Contact information included on the back cover or at our website <http://www.medtl.net>).

When an exception or error occurs during the experiment, the current run step is terminated/stop. After resolving the error or exception, restart the run from beginning. The troubleshooting guide is shown in the following table.

No.	Fault Symptom	Fault Cause	Handling Method
1	The amount of liquid in the reagent wells is insufficient.	/	Contact the after-sales service of our company.
2	Reagent consumables cannot be fully inserted into the instrument.	The reagent consumables may be placed incorrectly.	Reposition the reagent consumables.
3	Reuse of pre-filled components	Please read the precautions in this manual before using the kit.	Re-extraction of nucleic acid is performed.
4	Poor extraction performance	Please follow the operation requirements in the manual.	Contact the after-sales service of our company.
		The temperature control components of the instrument may be abnormal.	Contact the after-sales service of our company.
		Other	Contact the after-sales service of our company.

* Ensure that the reagents have been preserved and used according to the manufacturer's instructions.

Quality Control

In accordance with Tianlong Company's ISO-certified Quality Management, each lot of Viral DNA and RNA Extraction Kit is tested against predetermined specifications to ensure consistent product quality.

Limitations of Test Methods

The system performance has been established through performance evaluation studies using swab wash buffers to purify viral DNA and RNA.











It is the user's responsibility to validate system's performance for any procedures used in their laboratory that are not covered by the performance evaluation studies of Xi'an Tianlong Science and Technology Co., Ltd.

Although the kit is intended for use in public health and scientific research, the purity and quality of extraction results are also affected by the testing instruments and personnel. Moreover, the kit uses a specially formulated eluent that can affect the absorbance value, so it is not recommended to use a UV rays' spectrophotometer to measure the extraction effect directly.

The extraction kit is intended for use with clinical diagnostic samples, forensic materials, and scientific research samples. The instrument and operator have an effect on the concentration and purity of the

extracted product. Any generated diagnostic results must be interpreted in conjunction with the other clinical or laboratory findings.

Safety Symbols and Signs

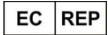
No.	Symbol	Implication
1		Catalogue number
2		Batch code
3		Contains sufficient for <N> tests
4		Use by date
5		Caution
6		Temperature limit
7		In vitro diagnostic medical device
8		Reminder
9		Manufacturer
10		Do not re-use
11		Conformed with EU standard
12		Authorized representative in the European Community

Contact Information

For technical assistance and more information, please contact our Technical Support Center at +86-29-82218051 (Tel), +86-29-82216680(Fax), inquiry@medtl.com or contact your local distributor.

For up-to-date licensing information or product-specific disclaimers, please see the respective User Guide. Tianlong User Guides are available at www.medtl.net or can be requested from Tianlong Technical Services or the local distributor.

IFU_T340H_EN © 2023 Xi'an Tianlong Science and Technology Co., Ltd., all rights reserved.